



*An Online CPD Course
brought to you by
CEDengineering.ca*

In-Situ Air Sparging

Course No: C14-001
Credit: 14 PDH

Gilbert Gedeon, P.E.



Continuing Education and Development, Inc.

P: (877) 322-5800
info@cedengineering.ca

This course was adapted from the United States Army Corps of Engineers (USACE), Publication No. EM 200-1-19, "In-Situ Air Sparging", which is in the public domain.

TABLE OF CONTENTS

	Paragraph	Page
Chapter 1. Introduction		
Purpose.....	1-1	1-1
Applicability.....	1-2	1-1
Distribution Statement	1-3	1-1
References.....	1-4	1-1
Background.....	1-5	1-2
Scope.....	1-6	1-3
Organization.....	1-7	1-4
Resources	1-8	1-4
Chapter 2. Technology Description and Underlying Physical Process		
Introduction.....	2-1	2-1
Overview of Air Sparging.....	2-2	2-1
Air Sparging Technology Options	2-3	2-3
Related Technologies.....	2-4	2-5
Summary of Physical Processes.....	2-5	2-6
Components of Injection Pressure	2-6	2-11
Groundwater Mixing.....	2-7	2-16
Associated Technical Issues.....	2-8	2-19
Technology Assessment: Effectiveness and Limitations.....	2-9	2-21
Technology Status.....	2-10	2-22
Conditions Amenable to IAS	2-11	2-23
Success Criteria.....	2-12	2-23
IAS Models	2-13	2-24
Chapter 3. Site Characterization and Feasibility Evaluations		
Introduction.....	3-1	3-1
Technology Screening Strategy.....	3-2	3-1
Pre-Design Data Collection Requirements	3-3	3-3
Feasibility Studies.....	3-4	3-21

	Paragraph	Page
Chapter 4. Pilot Tests		
Introduction.....	4-1	4-1
Pilot Testing Strategy.....	4-2	4-1
Pilot Testing Guidance.....	4-3	4-3
Chapter 5. Design Considerations for Air Sparging Systems		
Introduction.....	5-1	5-1
Design Strategy.....	5-2	5-1
Design Guidance—Subsurface.....	5-3	5-4
Subsurface Construction.....	5-4	5-10
Manifold and Instrumentation Design.....	5-5	5-16
Air Delivery Equipment Design.....	5-6	5-23
Power Distribution and Controls.....	5-7	5-26
System Appurtenances.....	5-8	5-28
Design Documents.....	5-9	5-30
Chapter 6. System Construction, Operation, and Maintenance		
Introduction.....	6-1	6-1
Construction Oversight.....	6-2	6-1
Operation and Maintenance Strategy.....	6-3	6-1
Operation and Maintenance Guidance—Below Grade Components.....	6-4	6-2
Operation and Maintenance Guidance—Precommissioning and Start-up.....	6-5	6-5
IAS System Operation, Maintenance and Monitoring.....	6-6	6-5
Chapter 7. System Shutdown and Confirmation of Cleanup		
Introduction.....	7-1	7-1
Shutdown Strategy.....	7-2	7-1
Shutdown Guidance.....	7-3	7-4
Chapter 8. Other Issues		
Introduction.....	8-1	8-1
Legal and Regulatory Issues.....	8-2	8-1
Patent Issues.....	8-3	8-2
Safety.....	8-4	8-5

	Page
APPENDIX A	
References	A-1
APPENDIX B	
Henry's Law Constants (K_H , atm-m ³ /mol) for Selected Organic Compounds	B-1
APPENDIX C	
Air Velocity Measurement and Flow Rate Calculation	C-1

CHAPTER 1

Introduction

1-1. Purpose.

a. In-situ air sparging (IAS) is a rapidly emerging remediation technology for treatment of contaminants in saturated zone soils and groundwater. Injection below the water table of air, pure oxygen, or other gases may result in removal of contaminants by volatilization or bioremediation. Less commonly, IAS can be used to immobilize contaminants through chemical changes such as precipitation. This Engineer Manual (EM) provides guidance for evaluation of the feasibility and applicability of IAS for remediation of contaminated groundwater and soil and, as a secondary objective, describes design and operational considerations for IAS systems. The document is primarily intended to set US Army Corps of Engineers (USACE) technical policy on the use of the technology and to help prevent its application in inappropriate settings.

b. The foundation of Corps of Engineers environmental work is the Environmental Operating Principles as specified in ER 200-1-5. These seven tenets serve as guides and must be applied in all Corps business lines as we strive to achieve a sustainable environment.

1-2. Applicability. This EM applies to all HQUSACE elements and USACE commands responsible for hazardous, toxic, and radioactive waste projects.

1-3. Distribution. Approved for public release, distribution is unlimited.

1-4. References. References are listed in Appendix A. The following references are suggested as key supplementary sources of information on IAS:

a. Technology Overview.

- (1) Johnson et al. (1993)
- (2) Marley and Bruell (1995)
- (3) Reddy et al. (1995)
- (4) USEPA (1995a)
- (5) Holbrook et al. (1998)
- (6) Navy (2001)
- (7) Leeson et al. (2002)

b. Monitoring.

- (1) Lundegard (1994)

- (2) Johnson et al. (1995)
- (3) Acomb et al. (1995)
- (4) Clayton et al. (1995)
- (5) Baker et al. (1996)
- c. Pilot Testing and Design.
 - (1) Wisconsin DNR (1993)
 - (2) Wisconsin DNR (1995)
 - (3) Johnson et al. (1993)
 - (4) Marley and Bruell (1995)
 - (5) Leeson et al. (2002)
- d. Modeling.
 - (1) Lundegard and Andersen (1996)
 - (2) Clarke et al. (1996)
 - (3) Leeson et al. (2002)
- e. Equipment Specification and Operation.
 - (1) USEPA (1992)
 - (2) Wisconsin DNR (1993)
 - (3) Wisconsin DNR (1995)
 - (4) Holbrook et al. (1998)
- f. Evaluation of System Performance.
 - (1) USEPA (1995b)
 - (2) Holbrook et al. (1998)
 - (3) Bass et al. (2000)

1-5. Background.

a. In 1997, in-situ air sparging (IAS) was classified as an innovative technology under USEPA's Superfund Innovative Technology Evaluation (SITE) program. IAS is an evolving technology being applied to serve a variety of remedial purposes. While IAS has primarily been used to remove volatile organic compounds (VOCs) from the saturated subsurface through stripping, the technology can be effective in removing volatile and non-volatile contaminants through

other, primarily biological, processes enhanced during its implementation. The basic IAS system strips VOCs by injecting air into the saturated zone to promote contaminant partitioning from the liquid to the vapor phase. Off-gas may then be captured through a soil vapor extraction (SVE) system, if necessary, with vapor-phase treatment prior to its recirculation or discharge. [Figure 1-1](#) depicts a typical IAS system.

b. IAS appears to have first been utilized as a remediation technology in Germany in the mid-1980s, primarily to enhance clean-up of groundwater contaminated by chlorinated solvents (Gudemann and Hiller 1988). Some of the subsequent developmental history of the technical approach may be found in the patent descriptions in [paragraph 8-3](#).

c. Because injected air, oxygen, or an oxygenated gas can stimulate the activity of indigenous microbes, IAS can be effective in increasing the rate of natural aerobic biodegradation. This is particularly important when considering the use of IAS at sites with readily biodegradable hydrocarbons, particularly petroleum-contaminated sites. It has been speculated that, similarly, anaerobic conditions might be able to be created by injecting a non-oxygenated gaseous carbon source to remove the dissolved oxygen from the water. The resulting enhanced degradation of organic compounds, such as chlorinated VOCs, to daughter products would result in increased volatility, which could improve the effectiveness of stripping and phase transfer during IAS.

d. IAS is generally considered to be a mature technology. It is a relatively easy technology to implement; it is well known to regulatory agencies; and the equipment necessary for IAS is generally inexpensive and easily obtained. Therefore, IAS is one of the most practiced engineered technologies for in-situ groundwater remediation. Critical aspects considered by many as likely to govern the effectiveness of an IAS system, such as the presence and distribution of preferential airflow pathways, the degree of groundwater mixing, and potential precipitation and clogging of the soil formation by inorganic compounds, continue to be researched and reported in conference proceedings and technical journals. There are innovative field techniques that can aid the understanding of the effectiveness of IAS, such as neutron probes for measuring the effective zone of influence (ZOI) and distribution of the injected gas. As IAS is often considered to be a straightforward technology, such techniques are not often implemented. However, when such data are collected, it is anticipated that the understanding of the mechanisms and processes induced by IAS will increase, as well as the ability to predict and measure its effectiveness.

1-6. Scope. The primary focus of this EM is to provide guidance for assessing the feasibility and applicability of IAS. Secondly, this EM describes design and operational issues related to implementing pilot- and full-scale IAS systems, although it is not meant to address design issues in detail. Because IAS technology is still evolving, this EM is intended to consolidate existing guidance and to stimulate the acquisition and reporting of new information that will continue to refine the technology.

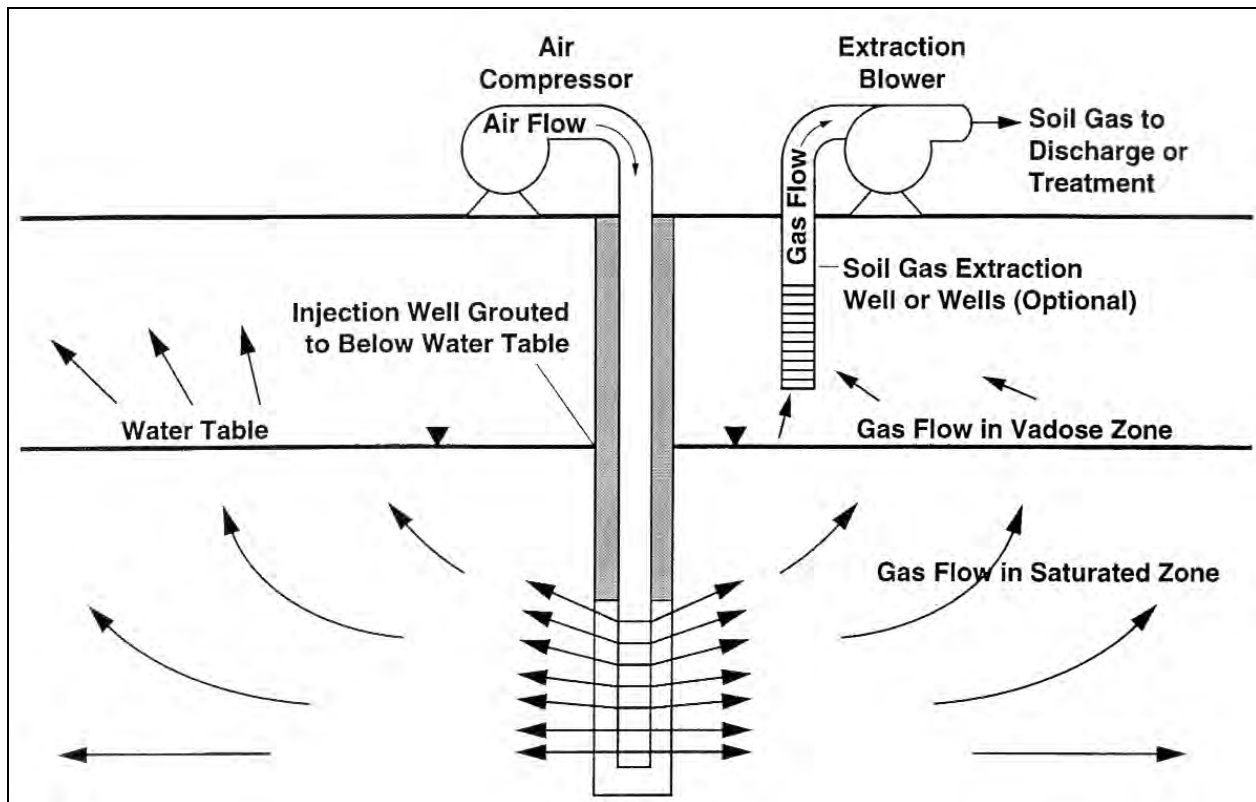

Figure 1-1. Typical In-situ Air Sparging.

The sparge well screen is situated vertically below a contaminated zone, such as a smear zone (Hinchee [1994]; reprinted with permission from *Air Sparging for Site Remediation*, Copyright Lewis Publishers, an imprint of CRC Press, Boca Raton, Florida ©1994.)

1-7. Organization. This EM is structured to show the progression from initial technology selection through testing, design, implementation, and closure. [Chapter 2](#) provides a description of IAS, including its underlying physical processes. Recommendations for site characterization and technology evaluation are presented in [Chapter 3](#). Strategy and guidance for pilot-scale testing are provided in [Chapter 4](#) and design considerations are presented in [Chapter 5](#). Issues associated with system operation and maintenance are discussed in [Chapter 6](#) and system shutdown procedures are introduced in [Chapter 7](#). [Chapter 8](#) presents administrative issues associated with implementing IAS. [Appendix A](#) provides references cited in the document. [Appendix B](#) provide a table of Henry's Law constants for selected organic compounds. [Appendix C](#) describes methods of calculating flow rates based on air velocity measurements.

1-8. Resources.

a. A variety of resources are available to assist in assessing the feasibility of IAS and designing an effective system. Resources include models for system design and optimization (see

paragraph 2-13), technical journals that summarize case studies and recent technical developments, and electronic bulletin boards and databases that provide access to regulatory agency, academic, and commercial sources of information.

b. Of the available electronic resources, the Vendor Information System for Innovative Treatment Technology (VISITT) database and the Alternative Treatment Technology Information Center (ATTIC) bulletin board are both maintained by the U.S. Environmental Protection Agency (USEPA) and provide an extensive compendium of acquired technology data. VISITT contains vendor information, ranging from performance data to waste limitations, while ATTIC contains primarily abstracts from technical journals, as well as conference announcements and related public interest information. USEPA also maintains a web page cataloging relevant IAS guidance documents, located at http://clu-in.org/techfocus/default.focus/sec/Air_Sparging/cat/Guidance/.

c. USACE maintains a web site that contains information on SVE, bioventing (BV), and other air-based remediation technologies. This web site lists useful documents and links to Federal bulletin boards and databases, located at <http://www.environmental.usace.army.mil/sve.htm>

d. Many of these electronic resources also contain information on IAS.

CHAPTER 2

Technology Description and Underlying Physical Process

2-1. Introduction. This chapter provides an overview of air sparging, describes various applications of the technology, and discusses the underlying physical processes that occur during IAS.

2-2. Overview of Air Sparging.

a. Introduction. Air sparging is the process of injecting air into the saturated subsurface to treat contaminated soil and groundwater. Air sparging mechanisms include partitioning of volatile contaminants from the aqueous phase to the vapor phase (stripping), for their subsequent transfer to and removal from the unsaturated zone, and transfer of oxygen from the injected air to the aqueous phase to enhance aerobic microbial degradation of contaminants in the saturated zone, termed biosparging. Air sparging may be used for these diverse applications, which are addressed, in turn, in subparagraph 2-2*b–e*.

(1) Treat saturated zone contamination in a source area (although its effectiveness in remediating non-aqueous phase liquids [NAPL] is subject to some fundamental physical limitations, especially with respect to dense NAPL [DNAPL]).

(2) Treat dissolved phase contamination in a plume.

(3) Contain a dissolved-phase plume.

(4) Immobilize contaminants through chemical changes.

b. Treat Saturated Zone in a Source Area.

(1) Saturated zone contamination exists at many locations where fuel hydrocarbons or organic solvents have been released into the subsurface. Such “source” areas contain contaminants dissolved in the aqueous phase and also typically contain NAPL. Groundwater pump-and-treat, which until recently was often relied upon to treat such saturated zone contaminants, is a very slow remediation process and has been judged as having met with little success except as a containment tool (NRC 1994). With the dawning of this recognition, attention turned to alternative technologies. Although air-based remediation technologies, such as SVE and BV, gained favor for treatment of unsaturated zone contamination, they do not apply to the saturated zone. IAS, however, is an air-based technology that is meant to be applied within the saturated zone. The view was widely expressed by early practitioners that IAS can achieve site closure—implying treatment of both dissolved-phase and non-aqueous phase contaminants if present—much more rapidly than pump-and-treat (Brown and Fraxedas 1991, Marley 1992a,b, Angell 1992). As more experience was gleaned from applying IAS at numerous sites, these and other practitioners have

tended to adopt a somewhat more circumspect view, especially with respect to its effectiveness in treating NAPL in the saturated zone and the capillary fringe.

(2) There are fundamental physical limitations on the effectiveness of air sparging for treating NAPLs. LNAPLs tend to form pools above the water table or discontinuous ganglia throughout the capillary fringe and smear zone. These LNAPL pools and ganglia represent potentially large sources of VOCs with relatively limited surface areas. The small surface area of such NAPL bodies limits the rate of interphase mass transfer of VOCs from NAPL into sparge air, in much the same way as it limits the transfer of VOCs from NAPL into groundwater. However, over time, pooled volatile LNAPL, such as gasoline or jet fuel, and residual NAPL in the smear zone may be remediated by combined IAS/SVE approaches. Laboratory experiments performed with poorly graded coarse sand imbued with benzene NAPL “pools” demonstrated fairly rapid NAPL removal (Adams and Reddy 2000). The potential for remediation of less volatile LNAPLs (e.g., diesel or fuel oils) is less promising, relying more on biodegradation potential than enhanced volatilization of the LNAPL.

(3) Air sparging is particularly challenged to remediate DNAPL sites. In addition to the limitations of interphase mass transfer, the effect of capillary pressures on DNAPLs and sparged air operates to inhibit these two phases from contacting one another in the subsurface. In even moderately heterogeneous aquifers, DNAPLs tend to pool atop low-permeability lenses when they lack the entry pressure to penetrate the lower-permeability lens. Sparged air likewise often fails to enter lower-permeability lenses from below, because the capillary pressure resisting air flow through low-permeability units is even greater than that resisting the DNAPL. As a result, the sparged air tends to flow around the lower-permeability lens before continuing upward, never contacting the DNAPL resting atop the lens. Modeling performed by McCray and Falta (1997) suggest that DNAPL can be remediated by IAS in homogeneous media. These results have been confirmed in a laboratory setting, where TCE NAPL was removed by IAS from uniform coarse sands, though at slower removal rates than benzene LNAPL in an equivalent setting (Adams and Reddy 1999). However, numerical simulation (McCray and Falta 1997) of IAS in heterogeneous media concluded that DNAPL remediation by IAS is not favored, although it may be possible (if not cost effective) with extremely detailed site characterization information and carefully positioned well screens.

(4) A secondary effect of applying IAS in a source area is that the resulting reduction in hydraulic conductivity in the source area reduces the rate at which groundwater flows through that area, thereby reducing the rate at which contaminants migrate from the source area, which in turn reduces the rate at which a downgradient plume is supplied with contaminants.

c. Treat Dissolved Phase in a Plume Area. Another common application of IAS is for the treatment of dissolved phase contamination in a plume, downgradient of source areas. Configurations used for aqueous-phase treatment include the installation of an array of air sparging points, spaced so that each individual ZOI overlaps. When the source is a release of light non-aqueous phase liquid (LNAPL) (e.g., gasoline, fuel oil), the dissolved plume is often primarily situated near the water table surface of an unconfined aquifer. In such cases IAS points

can be conveniently located just below the plume to obtain the desired coverage. In a survey of 32 IAS case studies, Bass and Brown (1996) concluded that performance of IAS systems was generally better in systems treating dissolved-phase plumes than in systems treating adsorbed contaminants.

d. Contain a Dissolved Phase Plume.

(1) A third type of application of IAS is to contain a dissolved-phase plume. A series of sparge points with overlapping zones of influence can be arrayed along a line perpendicular to the plume axis and within or just downgradient of the leading edge of the plume, so as to intercept it (e.g., Wade 1996, Payne et al. 1996). This approach can also be incorporated within a funnel-and-gate configuration (Pankow et al. 1993), in a manner similar to the placement of a permeable barrier or reactive wall, although use of impermeable funneling barriers, such as sheet walls, are not necessarily required with sparge curtains. The objective of this approach is to halt contaminant migration.

(2) Care must be taken to prevent diversion of a groundwater plume around a sparge curtain or sparge gate. Groundwater can be diverted with implementation of IAS if air saturation values increase within the sparge zone, causing marked reductions in hydraulic conductivity there. This problem can be avoided by cycling or pulsing the IAS system, as is discussed in greater detail in [paragraph 6-6b](#). With sparging trenches, the use of high permeability material can offset to some degree the loss of hydraulic conductivity attributable to air saturation.

(3) See “Design Guidance for Application of Permeable Barriers to Remediate Dissolved Chlorinated Solvents” for information on funnel-and-gate systems or contact the USEPA Remediation Technologies Development Forum (RTDF) Permeable Barriers Working Group through USEPA’s Technology Innovation Office, 401 M Street, S.W., Washington, D.C. 20460.

e. Immobilize Contaminants through Chemical Changes. A fourth way to potentially use IAS is to immobilize contaminants through chemical changes (e.g., oxidation of arsenic, its subsequent complexation with iron hydroxides, and precipitation). Aeration increases dissolved oxygen concentration in the groundwater, and causes an accompanying increase in oxidation-reduction potential (redox). Consequently, redox reactions can occur at or near IAS wells. While iron fouling of the IAS well screen would represent an adverse result, which would need to be avoided, immobilization within the aquifer of unwanted inorganic compounds, such as heavy metals, is a beneficial, although potentially reversible, effect (Marley and Hall 1996).

2-3. Air Sparging Technology Options. Air sparging can be performed by any of the following techniques.

a. Injection into the Saturated Zone. Injecting air directly into the saturated zone, termed in-situ air sparging, shall be emphasized in this EM. SVE often accompanies IAS to control fugitive emissions of the VOCs that are carried to the unsaturated zone by IAS.

b. Vertical or Horizontal Wells. IAS has been performed using horizontal sparging and venting wells at numerous sites, including at the USDOE Savannah River Site demonstration (Lombard et al. 1994). At the Hastings East Industrial Park, Hastings, NE, USACE U.S. Army Engineer District, Kansas City, employed a horizontal sparging well to intercept a dissolved plume downgradient of a source area, as well as a vertical sparging well within the source area itself (Siegwald et al. 1996). Horizontal and vertical wells can also be mixed within a single sparge and vent well field to give greater control of injection or extraction rates at various locations, and to optimize costs.

c. Injecting Gases Other than Air. Injecting gases other than air (e.g., pure oxygen, ozone, methane, butane, propane, pure nitrogen, or nitrous oxide) may enhance the speed at which bioremediation proceeds or alter the conditions under which it occurs. The USDOE Savannah River Site demonstration (Lombard et al. 1994, Hazen et al. 1994) successfully injected gaseous nutrients to stimulate aerobic methanotrophic cometabolic biodegradation of trichloroethylene (TCE). Methane was injected to serve as a source of carbon (injected continuously at a level of 1% methane in air, or intermittently at 4% methane in air), along with nitrous oxide (0.07%) and triethyl phosphate (0.007%) to serve as gaseous sources of nitrogen and phosphorus, respectively. Over the period of the multiyear demonstration, the majority of the estimated contaminant mass was removed. An additional discussion of these techniques is provided in [paragraph 5-8b](#).

d. Ozone Sparging. Sparging with a mixture of air and ozone has been used to address organic contamination in ground water through chemical oxidation. Contaminants treated have included TCE and methyl-tert-butyl ether (MTBE). Though anecdotal reports suggest contaminant removal, the contribution from chemical oxidation is difficult to quantify. The stability of the ozone in a natural aquifer environment may be quite limited and the short half-life for ozone greatly limits the distance ozone can diffuse from channels of coarser grained soils. Oxidation in saturated pores is therefore quite limited in most circumstances. Contaminants may also diffuse to coarse-grained channels and oxidation may occur in the vapor phase. Whether the contaminant removal is through volatilization and capture in the vadose zone (the case with common in-situ air sparging) or through chemical oxidation in the channels, the contaminant removal is limited by the diffusion to the channels. The benefit of ozone injection is not clear for readily volatilized contaminants and would likely be limited for less volatile contaminants if the oxidation is to occur in the vapor phase. Some vendors of ozone sparging claim the ozone travels as microbubbles through the formation, but other work clearly shows that gases travel through saturated porous media in channels (see [paragraph 2-5a](#)). The basis of the vendors' claims of microbubble transport has not been well documented. The advantage of gas transport as microbubbles, if such occurs, is an increase in the air-to-liquid interfacial area that increases the rate of partitioning of the contaminant out of solution.

e. Injecting Steam.

(1) Steam can be injected in conjunction with, or instead of, air to incorporate a thermal treatment element to traditional air sparging technology. Steam injection has been employed successfully to remediate VOC-contaminated aquifers that would otherwise be difficult to remediate using traditional IAS and to remediate contaminants not amenable to traditional IAS (EPA 1997a,b, 1998).

(2) Steam injection design and operation are subject to many of the same constraints as air stripping. Considerations related to multi-phase flow (i.e., preferential flow paths) are important in determining whether steam injection has the potential to succeed at a site. However, because steam incorporates an element of thermal treatment, the necessary vapor-water contact area can be substantially less than for traditional air sparging. Because the thermal conductivity rates are much higher than diffusive mass transfer between vapor filled pores and the surrounding water-filled pores, steam injection can affect a larger volume of soil for a given vapor-phase saturation. The lateral distribution of heat is further enhanced by the horizontal flow of hot condensate from injection wells. As steam will condense in the cooler parts of the subsurface, the vapor phase will not initially reach the vadose zone and this condensation front will migrate from the steam sparging/injection well until breaking through to extraction wells or the water table. To enhance vapor-phase transfer of contaminants and to provide oxygen for destructive oxidation processes, the steam is sometimes amended with air.

2-4. Related Technologies.

a. IAS is related to several other recognized remediation technologies, either as earlier versions or complementary techniques.

(1) The aeration of a well bore or tank is similar to air stripping for removal of VOCs from water, except that the stripping process is conducted within the well or container instead of in a packaged tower or tray tower.

(2) The introduction of oxygen to the region below the water table is directly related to in-situ bioremediation. IAS can be an alternative to other means of introducing oxygen into the saturated zone.

(3) The use of air for conveyance of VOCs is related to the process of SVE, which is often used in the vadose zone above IAS to recover the stripped VOCs.

b. In-well aeration is a method that introduces air into the lower portion of a submerged well pipe, so that air bubbles rise within the pipe, with associated vapor-to-liquid and liquid-to-vapor mass transfer. This groundwater circulation well (GCW) technology has been termed in-well aeration (Hinchee 1994) and is related to airlift pumping. In its most common configura-

tions, placement of two screens, one at the bottom of the pipe and a second at the water table surface, enables aquifer water to be drawn into the pipe at its lower end and aerated and stripped water to exit at or above the ambient water table (Figure 2-1). Depending on the degree of anisotropy (i.e., provided the anisotropy is not too great), this circulation may create a widespread toroidal convection cell within the aquifer (Herrling et al. 1991). As with IAS, SVE is often employed to extract and treat the vapors brought upward within the well pipe. All of the factors that limit the effectiveness of pump-and-treat also limit the effectiveness of GCW technology. Recent demonstrations of the GCW technologies have shown mixed success. Though definite contaminant concentration reductions have been observed, the hydraulic performance has been difficult to evaluate. The performance has been particularly disappointing in highly anisotropic (vertical/horizontal) aquifers (NRL/PU/6115-99-384). Paragraph 8-3 describes patents on several potential configurations of in-well aeration. Otherwise this EM focuses on IAS, rather than GCW, technology.

c. Pneumatic fracturing, a technique of injecting a high-pressure gas or liquid into the subsurface to enhance airflow in tighter formations (e.g., silt and clay), may not be beneficial to IAS unless fractures can be controlled so as to be closely spaced. Otherwise, diffusion-limited mass transfer in low-permeability strata will limit IAS effectiveness. However, pneumatic fracturing has greater potential for steam applications, for which conductive heat transfer reduces the need for closely spaced fractures.

d. Other enhancements to IAS have also been introduced. This EM attempts to encompass a broad view of IAS's potential capabilities and its limitations, as currently understood.

2-5. Summary of Physical Processes.

a. Detailed descriptions of the pneumatics and hydraulics of IAS have been presented by several authors (e.g., Johnson et al. 1993, Ahlfeld et al. 1994); a somewhat abbreviated discussion will be offered here. During the early years of IAS, it was commonly assumed that IAS produces small air bubbles that rise within the aquifer, which we may think of as "the aquarium model." Illustrations of the aquarium model frequently showed a conical distribution of air bubbles originating at the sparge point and moving upward and outward to the water table (Brown and Fraxedas 1991, Angell 1992). It was later demonstrated in bench-scale research that bubble flow can occur, but only in porous media having relatively large (more than 1- to 2-mm diameter) soil grains and correspondingly large interconnected pores, such as in deposits consisting entirely of coarse sands or gravels (Ji et al. 1993, Brooks et al. 1999). In finer-grained soils, saturated-zone airflow resulting from air injection occurs in discrete pore-scale or larger-scale channels, rather than as uniform bubbles (Johnson et al. 1993, Ji et al. 1993). More recently, Peterson et al. (2001) have described a third airflow geometry, termed "chamber flow," that they have observed in soils with grain size of approximately 0.2 mm. Chamber flow is characterized by much higher air-filled volumes than would be expected from channel flow. Each of these geometries has different implications for the amount of air-to-water contact that governs the effectiveness of IAS.

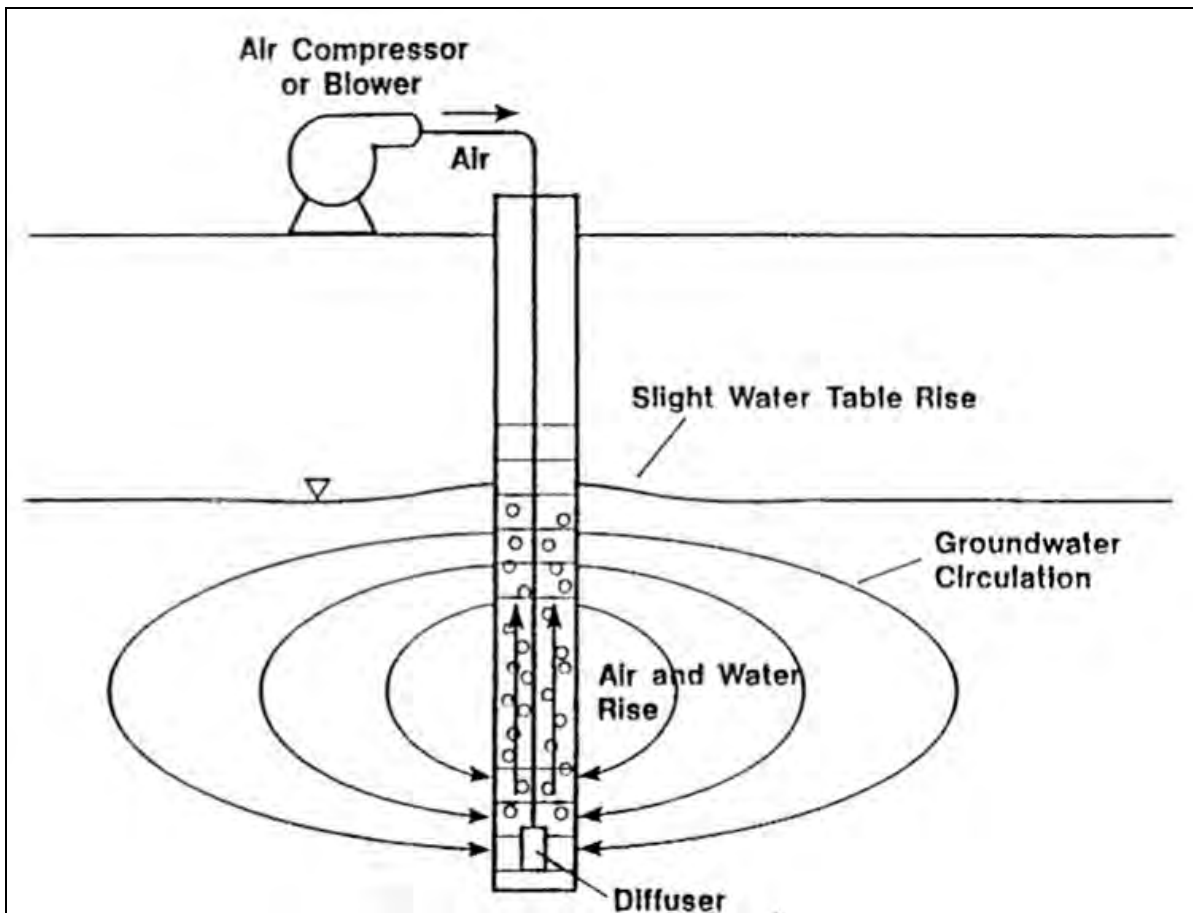

Figure 2-1. Typical in-well aeration application (after Hincbee [1994]; reprinted with permission from *Air Sparging for Site Remediation*; copyright Lewis Publishers, an imprint of CRC Press, Boca Raton, Florida. ©1994.)

(1) The situations in which bubble flow is the dominant airflow geometry are infrequent in actual IAS implementations. Aquifers with grain sizes exceeding 2 mm are not common. In addition, these aquifers must not have significant silt contents to fill the pores between the larger grains. However, in aquifers that are composed of large particle sizes, with associated large pore sizes, bubble flow dominates. Bubble flow, in which discrete air bubbles migrate upwards through the porous medium via a tortuous path, results in good air-to-water surficial contact and reasonably uniform distribution throughout the soil. Roosevelt and Corapcioglu (1998) observed in laboratory experiments using gravel-sized media (4 mm glass beads) that the rate of bubble rise is a function of the bubble size, is relatively constant once the bubble is formed, and is not a function of the depth in the water column.

(2) [Figure 2-2](#) depicts channel flow at the pore scale, and [Figure 2-3](#) illustrates channels at a larger scale for the cases of (a) IAS in homogeneous sand, and (b) IAS in heterogeneous sand. This airflow geometry can be described as air flow through distinct “capillary tubes” or interconnected gas filled pores. This view of IAS describes it as a type of multiphase flow, in which a

continuous gaseous phase under pressure displaces the liquid phase from a sequence of pores and pore throats to create bundles of capillary tubes. Channel flow occurs if the resistance to flow in a pore throat (i.e., capillary pressure) is larger than the buoyancy forces associated with a bubble the size of the associated pores. In this case, the air present in an air-filled pore will remain stationary, until sufficient air pressure builds “behind” the bubble to overcome the capillary resistance. The additional pressure is provided by the air connection to the air source (i.e., the sparge well) through a channel that “grows” as additional pores are added to the channel or capillary tube (Brooks et al. 1999). The larger-scale channels depicted in [Figure 2-3](#) represent a longitudinal extension of the pore-scale displacement process, and are most apparent when air-flow occurs predominantly within preferred pathways. In the case of IAS in uniform, unstructured silt or fine sand, large-scale channels will not be evident, although air displacement at the pore-scale still takes the form of capillary fingering (Clayton 1996). In the more common case of IAS in non-uniform soil, large-scale channels appear to predominate. Note that, for channel flow, the air and water saturations appear to conform to conventional pressure-saturation theory described by van Genuchten (1980) and others. The implication is that air flow can be reasonably simulated for this particle-size range by existing multiphase models.

(3) Chamber flow is a new concept that describes an IAS airflow geometry that is different than channel flow and is characterized by (Peterson et al. 2001).

- (a) Significant horizontal flow component.
- (b) Air-filled porosity within a region that is demarcated by a distinct, irregular boundary.
- (c) Predominantly vertical inlet and outlet channels between horizontal “chambers.”

(4) The laboratory research that led to these characterizations was done in visualization tanks, 127 cm high × 252 cm wide × 9 cm deep, filled with fine sand (grain size ~ 0.2 mm) mixed with reduced iron filings (10:1 volume ratio). After a period of sparging, the extent of air saturation within the soil was determined by sectioning the soil and visually observing oxidized iron (Peterson et al. 2001.) These experiments concluded that the spatial extent to which chamber flow affects the sediment column is highly variable, but its effect may exceed 50% on an area basis, or nearly 30% on a volume basis. These values appeared to be higher than observed in similar laboratory experiments using larger grain-sized media with resulting channel or bubble flow (Peterson et al. 2001).

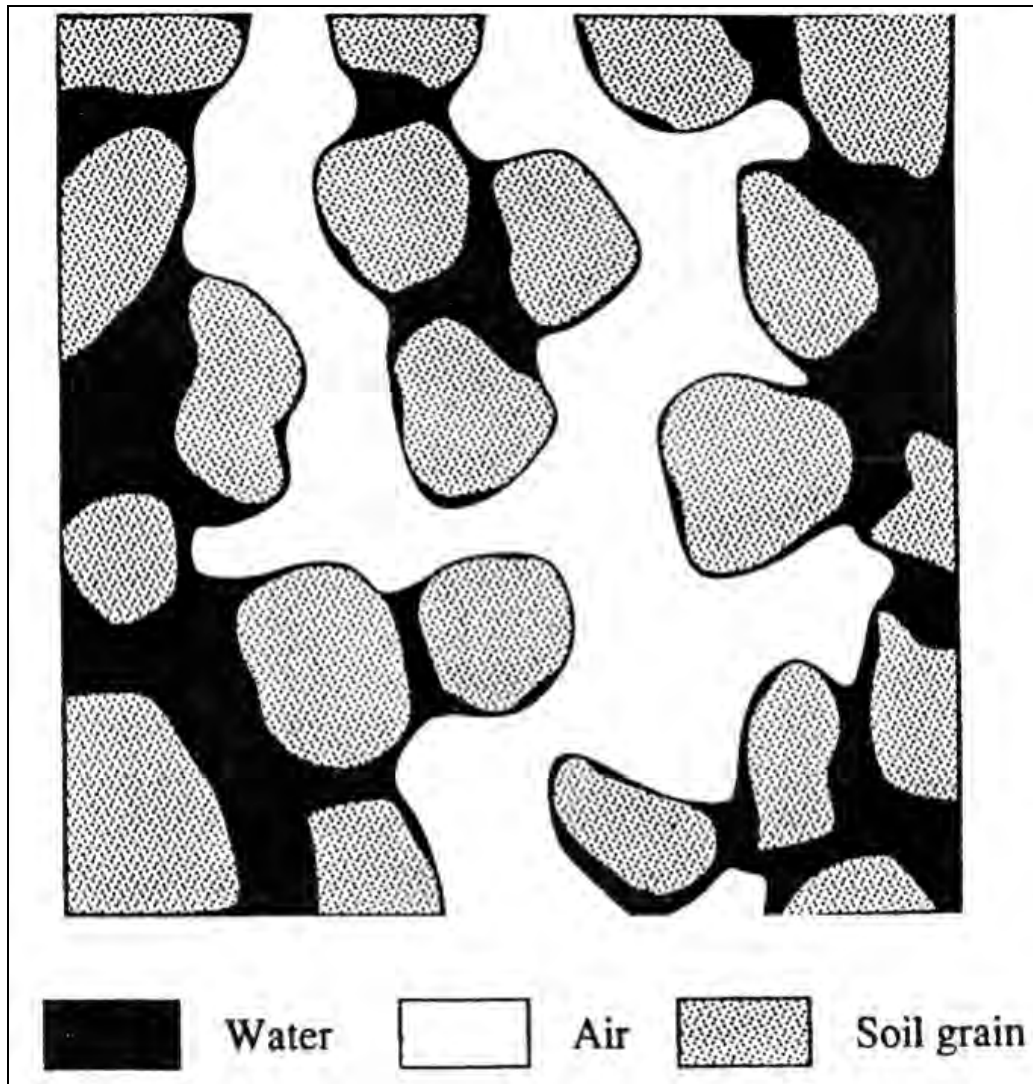

Figure 2-2. Schematic of channel flow at the pore scale showing interfaces between air and water (from Ahlfeld et al. [1994]; reprinted by permission of Ground Water Monitoring & Remediation; Copyright 1994; All rights reserved).

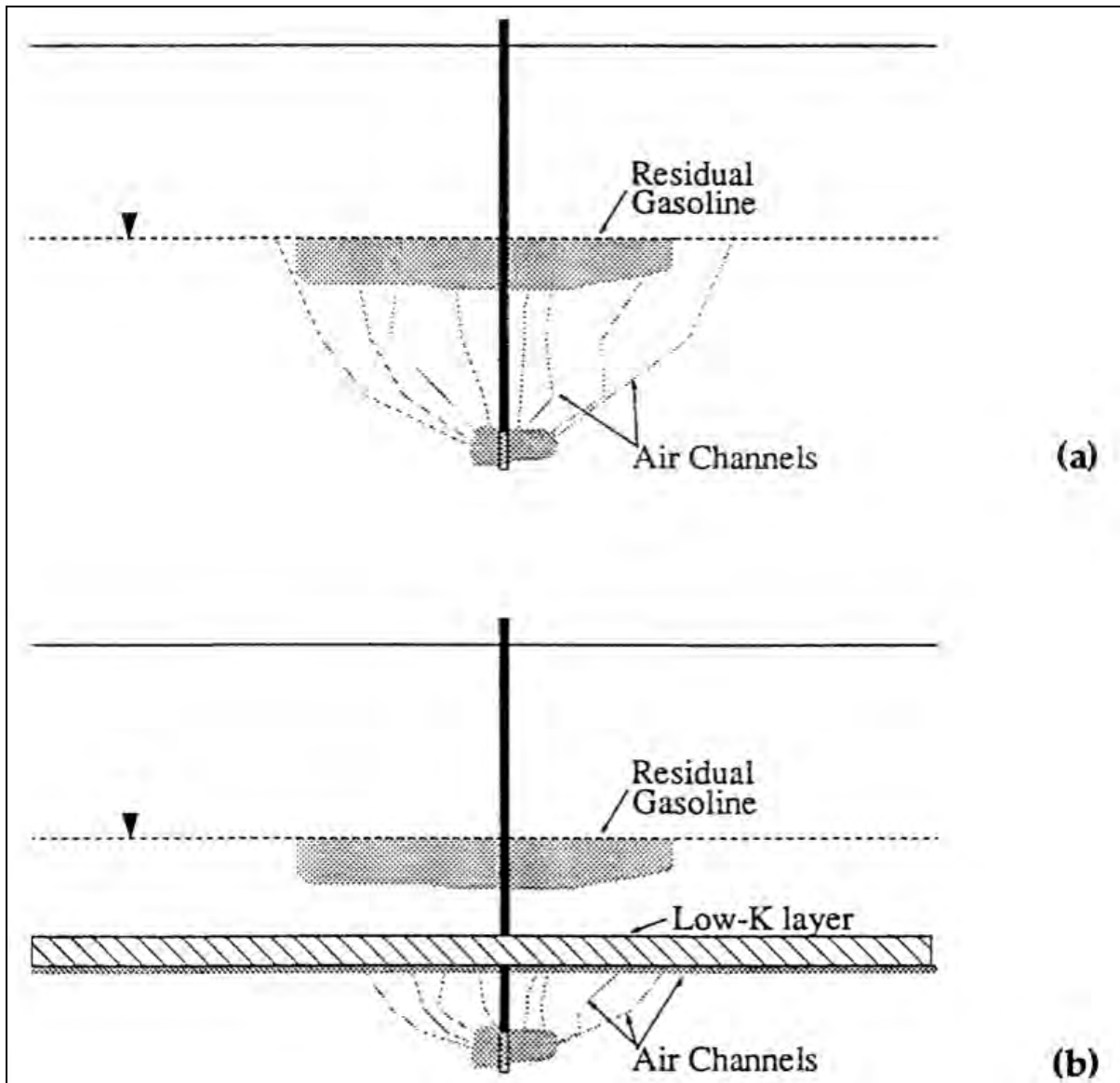

Figure 2-3. (a) Schematic drawing of airflow during in-situ air sparging in homogeneous sand; (b) schematic drawing of airflow during in-situ air sparging in heterogeneous sand (from Johnson 1994; reprinted by permission for *Air Sparging for Site Remediation*: copyright Lewis Publishers, an imprint of CRC Press, Boca Raton, Florida; ©1994.)

b. Both soil stratigraphy and heterogeneity have a profound influence on the location of air flowpaths and density (i.e., air-filled porosity). For example, air injected into moderately permeable soil beneath laterally continuous, low permeability layers will tend to induce horizontal airflow through the higher permeability layer. This will result in little or no air flow into the lower permeability (i.e., confining) layer and possibly air pocket formation beneath the confining layer (Figure 2-3b). Soil layers characterized by low hydraulic conductivity, even if thin, can have very high entry pressure requirements and may permit very little upward movement of air through the aquifer. Soil layers characterized by high permeability can also prevent upward movement of air beyond them, because the entry pressure from the high permeability layer to the overlying lower permeability strata will likewise favor lateral movement of air over continued upward movement. Based on laboratory tank experiments, Reddy and Adams (2001) concluded that a permeability difference of one order-of-magnitude is sufficient to prevent migration of air from the higher permeability strata into the overlying lower permeability. This principle held true, even when the overlying layer was coarse uniform sand ($K = 4.6 \times 10^{-2}$ cm/s) and the sparged layer was coarse gravel ($K = 1.6$ cm/s).

2-6. Components of Injection Pressure. Whatever the geometry of the displacement, the injection pressure measured at the well head required to accomplish it has several components, as will be presented in the following. Note that the friction loss between well head and screen is only part of the injection pressure requirements—there is also the loss in the piping to the well and all the fittings. The following subparagraphs emphasize the loss between the well head and the screen because that is the portion that affects the injection pressure that can be measured at the well head.

a. Hydrostatic Pressure. A key component of the injection pressure is the hydrostatic pressure needed to displace the column of water standing in the well pipe:

$$P_h = \rho_w g (z_s - z_w) \quad (2-1)$$

where

P_h = hydrostatic pressure ($\text{g cm}^{-1} \text{s}^{-2}$)

ρ_w = density (g cm^{-3}) of the water

g = gravitational acceleration (cm s^{-2})

z_w = pre-sparging depth (cm) to the free-water surface within the sparge well

z_s = depth (cm) to the top of the IAS well screen.

Considering that $1.01 \times 10^6 \text{ g cm}^{-1} \text{ s}^{-2} = 101 \text{ kPa} = 14.7 \text{ psi}$, and that at typical values of water temperature and density, $14.7 \text{ psi} = 33.8 \text{ ft H}_2\text{O}$, it is useful to note that a hydrostatic pressure of 0.43 psi is required per foot of water column, i.e.,

$$P_h = 0.43 (z_s - z_w) \quad (2-2)$$

for P_h expressed in psig and z_w and z_s in feet. Table 2-1 presents conversions among various other units of pressure and pressure head.

b. Frictional Losses in Pipe. The second component of the injection pressure is the head-loss due to friction of fluid moving between the well head and the IAS well screen. Figure 5-6 of EM 1110-1-4001 is a friction loss chart (nomograph) for straight pipe for inlet air at 294 K and 101-kPa absolute pressure. Although the magnitude of friction loss can be significant, it may be neglected for typical applications of IAS such as ones that combine the following conditions: sparge well diameter ≥ 5 cm (2 in.), well pipe length ≤ 30 m (100 ft), and airflow rate ≤ 0.4 m³/min (15 cfm). For smaller sparge well diameters, longer well pipe lengths, or higher airflow rates, frictional losses will be more significant. Similar losses may also occur in aboveground piping and should be anticipated.

c. Filter Pack Air-Entry Pressure. The third component of the injection pressure is the air-entry pressure of the filter pack, if present between the well screen and the formation. This value tends to be quite small, i.e., < 10 cm H₂O (0.14 psi) for uniform sands (uniformity coefficient, $C_u \leq 2.5$) commonly used as filter pack. This will be so even in cases where the filter pack in a developed well is adequately preventing fines from the formation from entering the well. Therefore, once there is sufficient applied pressure to displace all the water within the sparge well down to the top of the sparge screen, air readily enters the filter pack and displaces water from it. Buoyant forces are expected to cause the air to accumulate first at the top of the filter pack.

Table 2-1
Pressure/Pressure Head Conversions

1 bar	Units of Pressure $= 10^5 \text{ N m}^{-2}$ $= 0.987 \text{ atmospheres}$ $= 14.5 \text{ psi}$ $= 10^6 \text{ dynes cm}^{-2}$ $= 100 \text{ kPa}$
and is equivalent to:	Units of Pressure Head $1020 \text{ cm column of water}$ $75.01 \text{ cm column of Hg}$

d. Formation Air-Entry Pressure. The fourth component of the injection pressure is the air-entry pressure of the formation, P_e which is related using capillary theory to the pore size of the largest pores adjacent to the filter pack:

$$P_e = 2\sigma/r = 4\sigma/d \quad (2-3)$$

where:

P_e = air-entry pressure (dynes/cm² = g cm⁻¹ s⁻²)

σ = surface tension (g s⁻²) of water in air

r = radius (cm) of the constrictions along the largest pores of entry

d = diameter (cm) of the constrictions along the largest pores of entry.

Under the assumption that pores are cylindrical and the solid-liquid contact angle is zero, Equation 2-3 can be used to calculate the air-entry pressures of pores of various size (Table 2-2). Air-entry pressures of formations range from negligible for coarse-textured media, such as coarse sands and gravels, to values of > 1 m H₂O (1.4 psi) for medium-textured soils, such as silts. Care needs to be exercised when using Equation 2-3 or Table 2-2 to predict air-entry pressures in soils consisting of a variety of pore-sizes, because the largest pores may not necessarily be continuous throughout the soil matrix. The inflection point, P_{infl} of a Van Genuchten (1980) curve fitted to the soil moisture retention data (Figure 3-2), which represents the predominant pore size within the soil (Baker et al. 1996), is therefore the recommended parameter to employ when estimating P_e . Under dynamic conditions, an initially saturated soil undergoing air entry will first begin to be permeable to air at this inflection point P_{infl} (White et al. 1972, Baker et al. 1996). P_{infl} is thus the effective air entry pressure that should be used for design (Baker and McKay 1997).

e. Air Entry Process. Where a range of pore sizes is present in the subsurface, which is almost always the case even in seemingly uniform sands, silts, or clays, initial air entry naturally takes place via the largest pores available. The largest pores are the paths of least resistance, owing to both higher intrinsic permeability and lower entry pressures. If the largest network of pores is capable of conducting all the air that is injected into the well, then the pressure will not rise above the air-entry pressure, and smaller pores will remain liquid-filled. If, however, the combined conductivity of the largest pores is insufficient to convey away from the well all the air that is being injected, the applied pressure will rise, exceeding the air-entry pressures of the next smaller pore-size class. As the capillary pressure of the soil rises (as it must with higher air saturations and lower water saturations), the air permeability also increases. (Capillary pressure is defined in EM 1110-1-4001.) If the airflow being conveyed into the well can now be accommodated, the air-filled porosity will not increase further; otherwise, the process of displacement of water from smaller pores will continue until a dynamic equilibrium is attained between applied pressure and airflow (Baker et al. 1996). Given that higher injection pressures are required to inject higher flow rates, higher air saturations and a wider extent of water displacement are therefore expected at higher injection flow rates (Johnson et al. 2001). This is limited by the degree to which the stratigraphy will allow air penetration. Clay lenses and layers may still not allow further expansion of the zone of influence or air saturation in portions of the target treatment volume. Adams and Reddy (2000) observed in laboratory sand tanks filled with coarse sand that increased airflow increases the rate of contaminant removal. They concluded that the zone affected by IAS did not change, but air saturation within the zone increased with increased flow. Additional air flow enhanced the mass transfer and transport mechanisms, but a limit was reached where additional increases in the rate of air injection did not yield faster contaminant removal.

Table 2-2
Representative Values of Air-Entry Pressure

Typical Soil Description	Diameter of Largest Pore (μm)	Air-Entry Pressure (psi)	Air-Entry Pressure (kPa)
Coarse sand, macropores	>1000	<0.044	<0.3
Fine to med. sand	100	0.44	3.0
Silt	10	4.4	30
Silty clay	<1	>44	>300

f. Implications. Unless the resulting air-flow channels are small, close together, and well-distributed, mass-transfer external to them of i) contaminants into the air-filled channels, and ii) oxygen in the reverse direction for aerobic biodegradation, will both be limited by aqueous-phase diffusion (Johnson 1994, Mohr 1995). Mohr (1995) proposed a conceptual model of the mass transfer across the air/water interface and the associated oxygen and hydrocarbon concentration profiles (Figure 2-4), and concluded that unless air-filled channels are small and well-distributed, diffusion-limited transfer will limit the effectiveness of IAS (Figure 2-5). The degree of soil homogeneity and isotropy are the most important determinants of air channel distribution during IAS. Soils such as interbedded sands and silts or other types of stratified deposits in which air permeability varies with direction or depth tend to sustain preferential airflow within the zones of higher permeability, which may or may not coincide with locations or layers having elevated contaminant concentrations. Uniform fine sandy or silty zones generally possess the most isotropic air permeabilities, and consequently are most appropriate for IAS as they are capable of producing a uniform and reasonably predictable ZOI. Conversely, soils such as massive clays having low values of air permeability are not amenable to IAS as excessively high air entry pressures can lead to soil fracturing and a low number of preferential flow channels conducting the entire air flow. An exception may be clays that are highly fractured. A recent API project completed in clay till produced significant mass removal with IAS. The till was highly fractured and as a result both NAPL and the IAS air flowed through the fractures (Johnson, R.L., Personal Communication, 1997). Research into the relationship between soil type, applied pressure, and airflow distribution is ongoing.

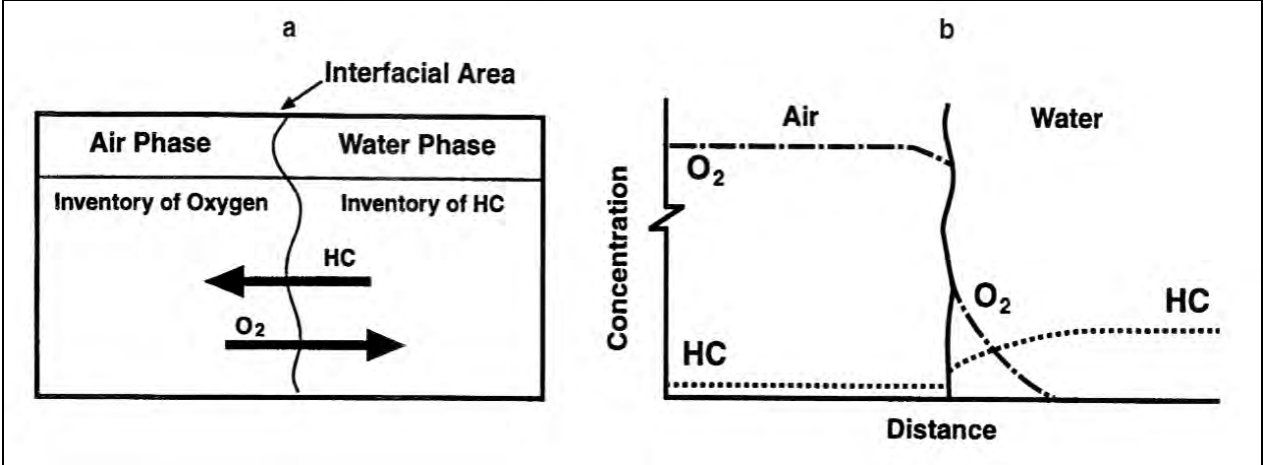

Figure 2-4. Mass transfer during IAS: (a) conceptual model, and (b) oxygen and hydrocarbon concentration profiles across the air/water interface (after Mohr 1995).

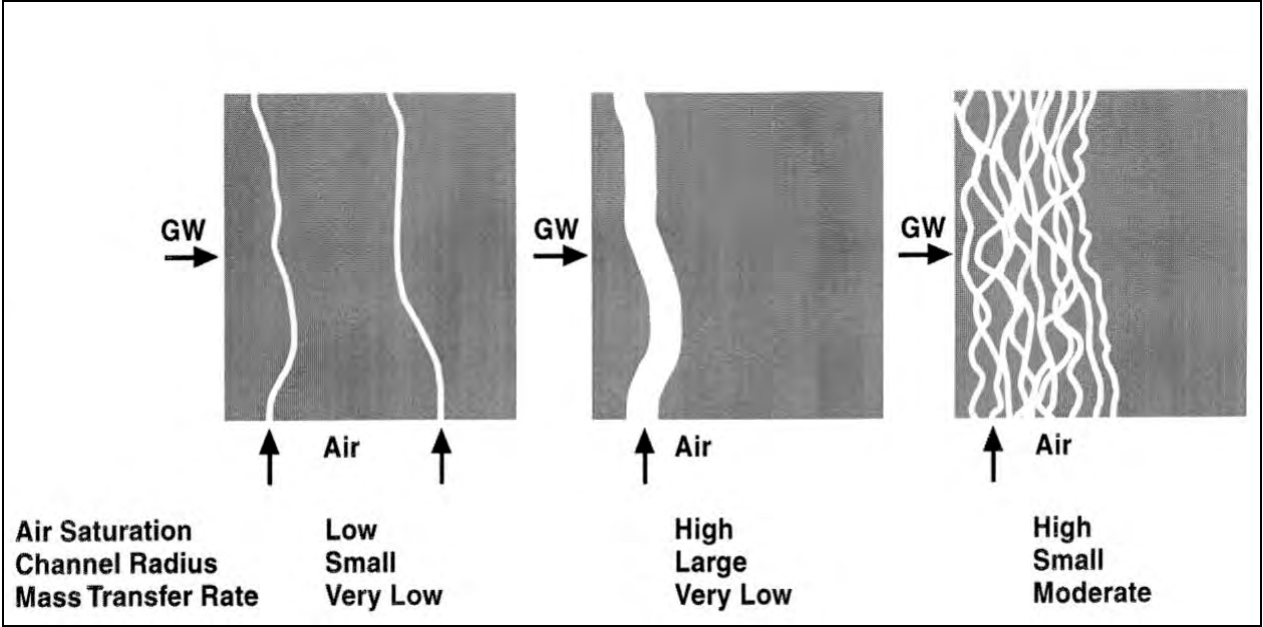

Figure 2-5. Effective Air sparging requires high air saturation and finely dispersed air channels. GW indicates groundwater flow (after Mohr 1995).

2-7. Groundwater Mixing.

a. Mixing Through Displacement.

(1) The introduction of air into a water-saturated formation displaces some of the water (Figure 2-6). The upward displacement of the water grows (“the expansion phase”), while air makes its way to the water table surface, creating a transient groundwater mound (Boersma et al. 1993). Researchers using geophysical visualization tools (Acomb et al. 1995, Schima et al. 1996) have observed a tendency in uniform sands for some portions of the initially dewatered zone to resaturate while stable airflow patterns become established (“onset of collapse”). Meanwhile, the mound dissipates radially outward (Figure 2-7) until a stable water table condition presents itself (Lundegard 1995). Upon depressurization of the sparging, such as when the compressor is turned off, many of the air-filled channels will resaturate as the formation reimbibes water, and the water table is seen to collapse temporarily. This condition too is transient and will not result in significant groundwater flow (Boersma et al. 1993, Lundegard 1994) (Figure 2-8). Turning the IAS system alternately on and off (“pulsing”) is a method of increasing air/water contact and groundwater mixing. Each displacement of water represents more vertical (and horizontal) mixing than is normally seen in groundwater, although the magnitude of the mixing effect appears to be relatively small (Johnson et al. 1996). This is a significant issue for cleanup because most subsurface processes are intrinsically mixing-limited, i.e., they are not fully mixed and thus are not well modeled as fully mixed reactors, to use chemical engineering terminology. The potential benefits of pulsing and associated mixing phenomena are described elsewhere (e.g., Johnson 1994, Clayton et al. 1995). It has been suggested that if the duration of the transient mounding period can be measured (i.e., by monitoring hydraulic head changes during IAS), this period may provide an estimate of the design duration and frequency of pulsing to deliberately maximize mixing of groundwater (Wisconsin DNR 1995). The degree to which mixing extends away from air-filled channels and thus helps overcome diffusion limitations is a matter of current research and debate (Johnson et al. 1996).

(2) Pulsed injection can be conducted by cycling injection on a single-well IAS system or by altering flow in adjacent injection wells in a field. Pulsed injection is most effective for mobile dissolved phase contaminants because of the induced mixing. It is uncertain whether pulsed injection is effective for sorbed contaminants, or for residual (immobile) NAPL, which, being immiscible with water, is not readily mixed. It has been observed that preferential flow channels tend to be re-established at the same locations during each pulse (Leeson et al. 1995). These re-appearing pathways may represent those that consolidate after each expansion phase. Information on pulsed operation is provided in [paragraph 6-6b](#).

b. Convection Currents. It has been suggested that convection currents may develop during IAS which could cause groundwater to circulate near the sparge well (Wehrle 1990). Such currents would form if the low density of the air stream causes the effective density of the fluid phase (air plus groundwater) near the well to be less than that of the groundwater at distances removed from the well, which would be anticipated only if air moves as discrete bubbles rather

than in air-filled channels. Such currents would provide a mechanism for circulating water. These features may help move oxygenated water, but only if there is sufficient mass transfer from the vapor phase to oxygenate the groundwater. Convection currents are not viewed as a significant mechanism during IAS, however, because the effective density of water is not reduced except for the exceptional case of bubble flow (paragraph 2-5) (Wisconsin DNR 1993).

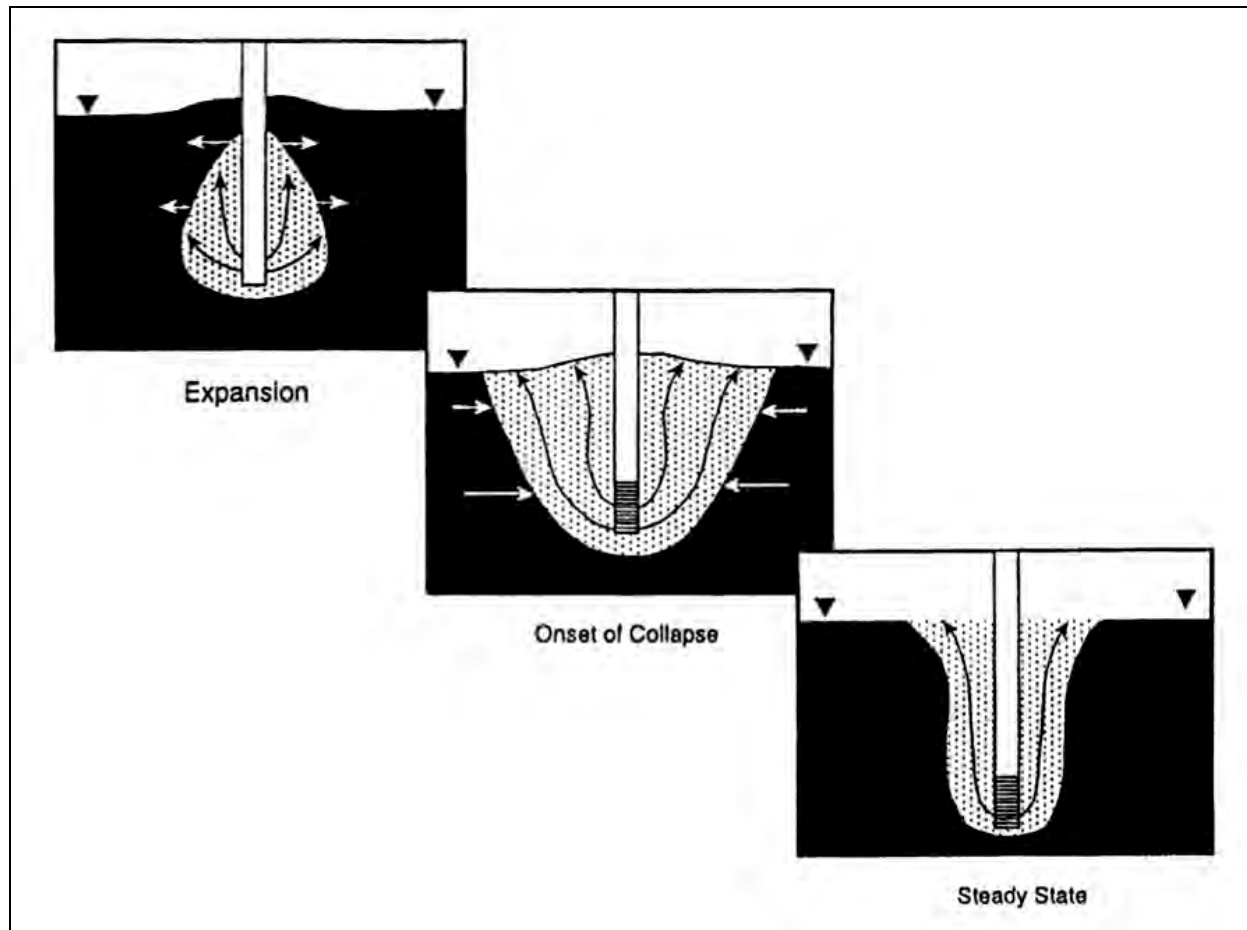

Figure 2-6. Schematic representation of the behavioral stages occurring during continuous air sparging. Black arrows indicate air flow; white arrows indicate water flow. Mounding first develops during the transient expansion stage, dissipates during the collapse stage, and is generally negligible at steady state (after Lundegard 1995).

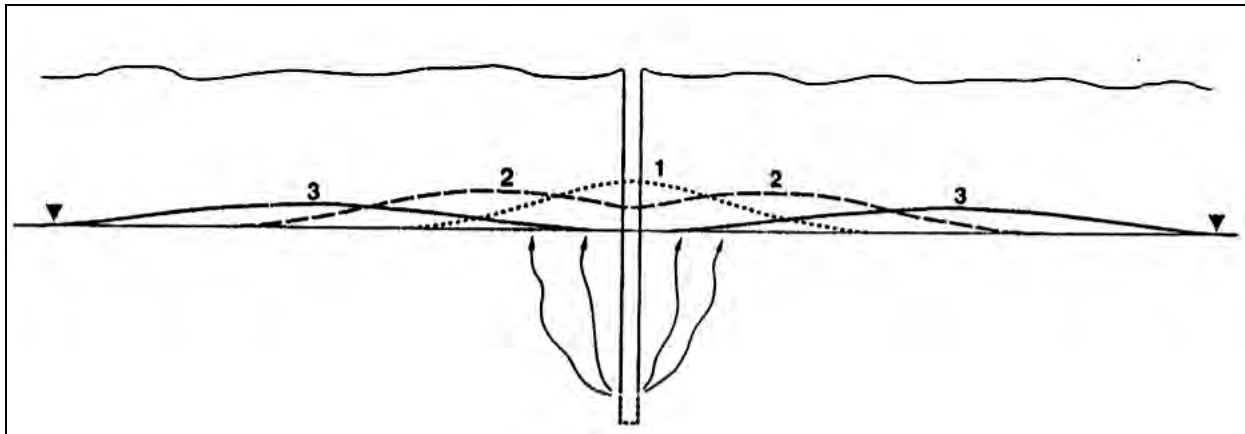

Figure 2-7. Schematic cross section representing progressive mounding behavior at three successive times: (1) expansion; (2) onset of collapse; (3) approach to steady state (after Lundegard 1995).

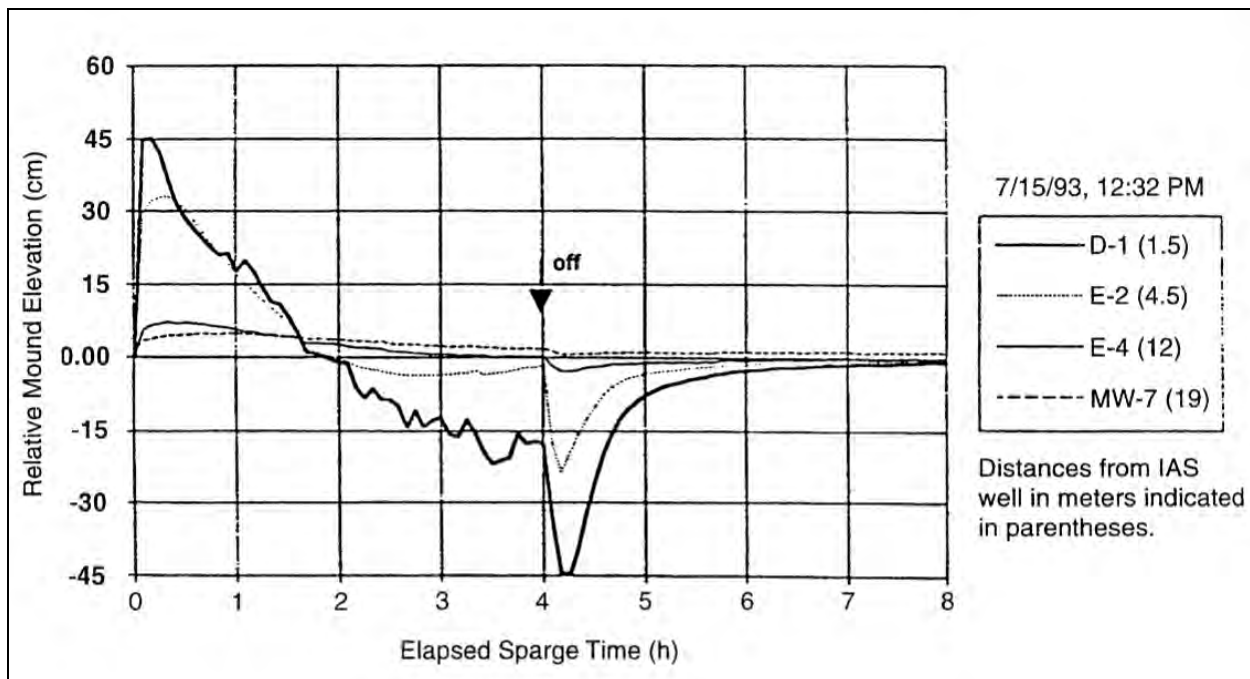

Figure 2-8. Changes in water table elevation vs. time (groundwater mounding) for four observation wells at various distances from the sparge well (from Lundegard 1994; reprinted by permission of National Ground Water Association; Copyright 1994; All rights reserved).

2-8. Associated Technical Issues. Aside from the issues described above that relate to conveying vapor through an aquifer, there are issues related to conveying the air to the injection points and from the vadose zone. At sites having very shallow water tables, the difficulties of capturing the vapors with SVE may result in fugitive releases of untreated VOCs. Care needs to be taken in handling the exhaust air to ensure that such releases are minimized. In particular, migration of vapors into occupied buildings must be prevented to avoid health or explosion risks. Although the equipment used for IAS is almost entirely “off-the-shelf,” the design must tie the individual items together into a system that moves the air in a controlled fashion. The control system requires careful consideration to meet this need. Also, the operational design can influence the need for operating permits, and these permits can affect the timing and schedule for a project. The types of permits that may be required are discussed in [paragraph 8-2](#).

a. Zone of Influence.

(1) The area sufficiently affected by a sparge well or well field is a primary design concern. Techniques applied to estimate the ZOI include identifying the extent of measurable differences in pressure, dissolved gas concentrations, and air-filled channels within the saturated zone. Gas composition or pressure distribution in the unsaturated zone can also be indicators of ZOI ([paragraph 4-3b\(7\)](#)). In this EM, ZOI is preferred over the more widely used “radius of influence” (ROI) in recognition that the effects of IAS tend to be non-uniform with respect to distance, depth, and direction relative to a sparge screen (Ahlfeld et al. 1994). Clayton (1996) proposed a working definition of the ZOI as the volume of the saturated zone with air-filled channels that are relatively closely spaced, and suggested this occurs where air saturation exceeds 10%. This EM recommends a similar definition of ZOI, but the suggested minimum air saturation that indicates an adequate density of air channels is instead 3% ([paragraph 5-3b](#)). The effective ZOI radial distance is likely to be no more than 5 m (or approximately 15 ft). This saturated zone ZOI may be substantially smaller than that indicated by changes in pressure or gas composition in the unsaturated zone ([paragraph 4-3b\(7\)](#)) (Lundegard 1994). Other potentially erroneous indications of ZOI also need to be discounted, such as evidence from monitoring wells that are serving as a conduit for injected air and therefore are subject to in-well aeration ([paragraph 3-2b\(2\)](#)), and evidence based on mounding that has been observed to extend far beyond locations of air channels ([paragraph 4-3b\(8\)](#)). In some cases, although a few air pathways may extend >30 m from the IAS well, they may not be within the zone where treatment is needed (i.e., the air may spread under confining layers.)

(2) Pulsed operation is designed so as to take advantage of the recurrence of the expansion phase ([Figure 2-6](#)), during which the ZOI is somewhat larger than during steady state IAS (McKay and Acomb 1996). Pulsing and cycling are discussed further in [paragraph 6-6b](#).

(3) Consideration should be given to the fact that not all hydrocarbons contained within the ZOI will be removed at the same rate. For example, at increasing distances from the sparge well, air flow velocities within a given channel must decrease because of frictional losses and accompanying pressure drop, in accordance with Darcy's Law or models of pipe flow, depending upon

the scale. As a result, the rates of interphase mass transfer and hence hydrocarbon recovery and enhanced biodegradation are reduced.

b. Promotion of Biodegradation.

(1) In addition to IAS stripping VOC from the groundwater, air sparging also stimulates aerobic biodegradation of many volatile and semi-volatile contaminants. Biodegradation will decrease or potentially eliminate the amount of VOC that must be captured and treated at the surface. When enhanced biodegradation is the primary intent of the air sparging system, then this technique is termed biosparging.

(2) Dissolved oxygen is often the factor that limits biodegradation in the saturated zone. IAS is potentially a very cost-effective way to increase dissolved oxygen (DO) levels in the desired zone. However, as the solubility of oxygen from air is rather low at normal groundwater temperatures (ranging from 8 ppm at 25°C to 13 ppm at 5°C), the rate that oxygen can be dissolved into groundwater is often slower than the rate that microbes consume the oxygen. Thus, it may be difficult to deliver adequate levels of oxygen to optimize biodegradation in contaminated regions.

(3) Despite this mass transfer limitation, IAS is generally the most cost-effective method available to introduce oxygen into the saturated zone. Other oxygen delivery mechanisms include injection of liquid hydrogen peroxide; sparging with pure oxygen; and slow release solid peroxide products such as Oxygen Release Compound (ORC). Per kilogram of oxygen delivered, IAS is typically orders of magnitude less expensive than other oxygen delivery methods.

(4) When considering biosparging, it is important to evaluate the relative masses of: i) oxygen that can be sparged and dissolved into the groundwater, and ii) degradable hydrocarbons present in the saturated zone. Estimating the mass of contaminant below the smear zone (i.e., the mass of dissolved contaminant and the mass of sorbed contaminant), the mass of oxygen necessary for biodegradation can be calculated. Typically, approximately 3 g of oxygen are necessary to biodegrade 1 g of petroleum hydrocarbon. Methods for estimating the rate of oxygen dissolution during biosparging are presented by Johnson (1994) and Mohr (1995). A comparison of the mass of oxygen necessary for biodegradation and an estimate of the rate of oxygen dissolution into groundwater during biosparging should be included as part of the evaluation of biosparging. This mass comparison can also be used to check design parameters of a biosparging system (such as the number of sparge points and the anticipated period of system operation) as developed according to the guidance provided in [Chapter 5](#).

(5) A possible negative effect of the growth of aerobic microorganisms is the potential for biofouling of IAS well screens or filter pack materials near the sparge well. Although biofouling is not typically a major problem, it is discussed further in [paragraph 6-4a](#).

(6) At some sites, anaerobic dechlorination of chlorinated ethenes (e.g., TCE) that occurs naturally in groundwater produces vinyl chloride (VC). IAS can inhibit the production of VC by

maintaining aerobic conditions and can also strip the VC from the groundwater. Anaerobic dechlorination of chlorinated ethenes and the conditions that affect this process are discussed at length in the U.S. Air Force's protocol on natural attenuation of chlorinated solvents, described by Klecka et al. (1996).

(7) In general, IAS stripping of VOCs is the dominant means of removing contaminant mass during the early stages of system operation, whereas biodegradation is more likely to be the dominant process of removing mass of aerobically degradable compounds later in an IAS system's operational period (Leeson et al. 2002). Modeling studies performed by Johnson (1998) suggest that enhanced biodegradation has the potential to contribute a significant portion of mass removal for aerobically degradable compounds when contaminant concentrations are less than 1 mg/L. Otherwise, volatilization effects predominate. The implication is that in source areas, volatilization is the initially dominant mode of mass removal, whereas in downgradient plumes, both volatilization and biodegradation can be important modes of mass removal.

2-9. Technology Assessment: Effectiveness and Limitations.

a. Advantages of IAS. The primary advantages of IAS over alternate remedial technologies are relative simplicity and low cost. IAS equipment is readily available and easy to install with minimal disturbance to site operations.

(1) IAS components can be installed during site investigations by completing borings as sparge wells, SVE wells, or monitoring points. Additional subsurface components can be installed cost-effectively via direct push methods, where the soil geology and required installation depth will permit their use.

(2) For certain contaminants, IAS can remediate through both in-situ stripping and promoting biodegradation.

(3) IAS is compatible with other remedial methods, such as those employed to treat vadose zone contamination (e.g., SVE, and bioventing [BV]).

(4) IAS can be employed to effectively limit off-site migration of dissolved contaminants.

(5) Once implemented, IAS systems require minimal operational oversight vs. SVE systems.

(6) For IAS systems not matched with SVE, waste streams are not generated, and therefore do not need to be treated.

(7) The technology is judged by many practitioners as being a potentially effective method available for treating smear zone contamination.

b. Disadvantages of IAS. Disadvantages to IAS over alternate remedial technologies are primarily related to site physical or chemical characteristics that either preclude contaminant removal or alter contaminant mobility to threaten potential receptors.

(1) Contaminants are not effectively removed by IAS when, because of low Henry's Law constants or low volatilities, they are not amenable to air stripping.

(2) Treatment is not effective for semi-volatile contaminants that do not readily degrade aerobically.

(3) Geological conditions, such as stratification, heterogeneity, and anisotropy, will prevent uniform air flow and cause IAS to be ineffective. The deeper below the water table that IAS wells are installed, the more likely it is that stratification will be encountered that will divert the airflow laterally.

(4) Free product (NAPL) present in amounts significantly greater than residual saturation may constitute a virtually inexhaustible source of dissolved VOCs that may come only into limited contact with injected air. This is especially likely to be a concern relative to DNAPLs that will generally be present farther below the water table than LNAPLs, and thus will tend to have even less contact with sparged air. Thus, the presence of significant amounts of NAPL can inhibit successful remediation by IAS. The likelihood of success is lower for sites that are more heterogeneous with broadly distributed NAPL.

(5) When a sparge curtain is used in an effort to contain a dissolved phase plume ([paragraph 2-2d](#)), the resulting zone of reduced hydraulic conductivity, can, if not managed, promote redirection of groundwater flow and allow the plume to bypass the IAS treatment zone.

(6) Potential exists for IAS to induce migration of contaminants, and to generate fugitive emissions. Fugitive emissions are not observed often, but are more problematic when IAS is used in shallow soil or bedrock.

(7) Additionally, a single IAS well has a limited areal coverage, and, consequently, a significant number of injection wells are commonly required.

(8) IAS poses the risk of forcing contaminant vapors into utility conduits, buildings, and sewer lines. Such vapors may, in extreme cases at petroleum-contaminated sites, represent explosion hazards. In many cases, the intrusion of uncontrolled contaminant vapors into buildings may represent health risks. As such, careful consideration and design of soil vapor extraction systems must be conducted where such risks may occur.

2-10. Technology Status. IAS has been implemented over the past decade at thousands of locations to address a variety of contaminants. IAS can currently be considered a mature remediation technology. Early research into IAS had primarily focused on defining air and

groundwater physical dynamics. More recently, research has been focused on the development of practical approaches to implementation, including evaluating “rules of thumb,” particularly for enhancing mass removal, reducing rebound effects, and enhancing bioremediation. Questions still remain about treatment duration, the impacts of site heterogeneities, and site closure, particularly at locations where regulatory targets require that sorbed contaminants must be removed.

2-11. Conditions Amenable to IAS. Primary considerations for sites amenable to IAS include the site geology and contaminant type and phase. [Table 2-3](#) provides a general summary of these considerations. Secondary considerations include adjacent receptors, whether currently threatened or potentially threatened after installing IAS, and infrastructure concerns, such as power availability, access, and proximity of active installations. It should be noted that Henry’s Law constants for various contaminants are specified for steady state conditions between phases. These may be optimistic indicators for actual IAS systems, in which dissolved concentrations in groundwater adjacent to air channels are not in equilibrium with groundwater concentrations distant from air channels. [Figure 2-9](#), IAS Implementation Decision Tree, displays a generalized description of the process of evaluating and implementing IAS.

2-12. Success Criteria. In a broad sense, IAS is successful if its application to a site results in regulatory “closure,” i.e., no further remediation work is required by the appropriate agency. Specifically, success consists of the following.

- a. Effective delivery of air or other gases into the desired zone.
- b. Distribution of the introduced gas through the saturated subsurface at the design ZOI.
- c. Achievement of the design loading of the vapor with VOC, or of the design biodegradation rate in the groundwater (which will vary depending upon concentration and dominant phase of remaining contaminant).
- d. Effective capture and treatment of the sparged vapor in the vadose zone near the water table (particularly to prevent intrusion of vapors into buildings at the site).
- e. Attainment of the design hydrocarbon removal rates from the subsurface.
- f. Removal of contamination to below regulatory levels.
- g. Achievement of a negotiated, risk-based closure following IAS can also be considered a successful outcome even if cleanup standards have not been met ([paragraph 7-2](#)). Other success criteria include achievement of the project objectives within the allotted schedule and budget.

2-13. IAS Models.

a. Although there are an increasing number of operational data available to evaluate the effectiveness of IAS systems, mathematical models may be useful in the design process. Information (i.e., site data acquired from laboratory and field-scale pilot tests) would be used as input parameters in a given analytical or numerical model. Several attempts have been made to generate mathematical and computer models that describe the processes associated with IAS. Most met with little success because little was known about the actual rate of mass transfer that was occurring during air sparging, and it was impossible to validate model results when compared to field data.

Table 2-3
Conditions Amenable to IAS

Parameter	–	o	+
Contaminant Type	Weathered Fuels Lubricating Oils Hydraulic Fluids Dielectric Fluids PCBs	Diesel Fuel Jet Fuel Acetone MTBE	MOGAS AVGAS Halogenated Solvents ¹ BTEX
Geology	Silt and clay (interbedded) Massive clay Highly organic soils Fractured bedrock Stratified soil Confining layers	Weakly stratified soils Sandy silt Gravelly silt Highly fractured clay	Uniform coarse-grained soils (gravels, sands) Uniform silts
Contaminant Phase	Free product	Sorbed	Dissolved
Contaminant Location	Within confined aquifer; near bottom of unconfined aquifer	Within shallow aquifer	Near water table
Contaminant Extent	Large plumes ²	Modest-size plumes	Small plumes
Hydraulic Conductivity (cm/s)	<10 ⁻⁵	10 ⁻⁵ to 10 ⁻⁴	>10 ⁻⁴
Anisotropy	High degree of anisotropy	Moderate degree of anisotropy	Isotropic

– IAS likely to have limited effectiveness

o IAS likely to provide some benefit

+ Well suited for IAS

¹ IAS is generally applicable to halogenated ethenes, ethanes, and methanes.

² Sparge curtains may be effective in managing migration within large plumes ([paragraph 2-2d](#)).

b. Prior to model development, a conceptual model must first be proposed. Early modelers assumed the injected air moved as isolated, random bubbles. With the recognition that injected air actually moves through discrete, continuous, air-filled channels separated by regions of complete water saturation, IAS models incorporating multiphase flow have been developed.

c. A number of investigators have advanced the principles associated with these conceptual models and have developed mathematical models to assist in the design of air sparging systems. Several noteworthy IAS models have been developed and are presented in the literature. Several are cited below:

(1) Norris and Wilson (1996) present the results of a sparging model based on air channeling and a biosparging model based on air channeling and VOC and oxygen transport driven by dispersion.

(2) Mohr (1995) presents an analytical solution for estimating the rate of biodegradation associated with air sparging.

(3) Rutherford et al. (1996) present the results of a one-dimensional finite difference model based on the equations for a cross-flow bubble column, which was used to calculate a lumped value of liquid mass transfer coefficient and interfacial surface area.

(4) The U.S. Army Engineer District, Seattle, has, in the past, used a numerical model called POREFLOW[®] to simulate air sparging. A public domain version of the model, POREFLO-3[©] is available (Runchal and Sagar 1989); however, the distributor has upgraded a proprietary version of the model (ACRI 1996). POREFLOW[®] runs on most any platform; the PC code is less than 1 Mb in size, but requires at least 10 Mb to operate the pre- and post-processor. POREFLOW[®] is a three-dimensional finite difference model that accounts for losses attributable to decay, solute transport, and partitioning. It is capable of simulating compressible fluids (e.g., air) and heat transport. Input parameters include the following.

(a) Porous media properties (e.g., hydraulic conductivity, permeability versus saturation relationships, pressure–saturation relationships, storage values, and density).

(b) Fluid properties (mass, density, viscosity as a function of pressure and mole weight of gases).

(5) TETRAD (DYAD 88 Software, Inc.) is a finite difference simulator, originally developed for the study of multiphase fluid flow and heat flow problems associated with petroleum and geothermal resource evaluation (Lundegard and Andersen 1996). Lundegard and Andersen (1996) modified the code for IAS applications to account for an air-soil, constant pressure, surface boundary condition. TETRAD is capable of simulating three-dimensional, multiphase flow in complex, heterogeneous, anisotropic systems. Vinsome and Shook (1993) describe the structure and solution methods for TETRAD.

(6) The NUFT (Non-isothermal, Unsaturated Flow and Transport) code is a multi-phase, non-isothermal, saturated/unsaturated, numerical transport model that would be very suitable for IAS modeling. It can be obtained with the DoD Groundwater Modeling System that would serve as a pre- and post-processor.

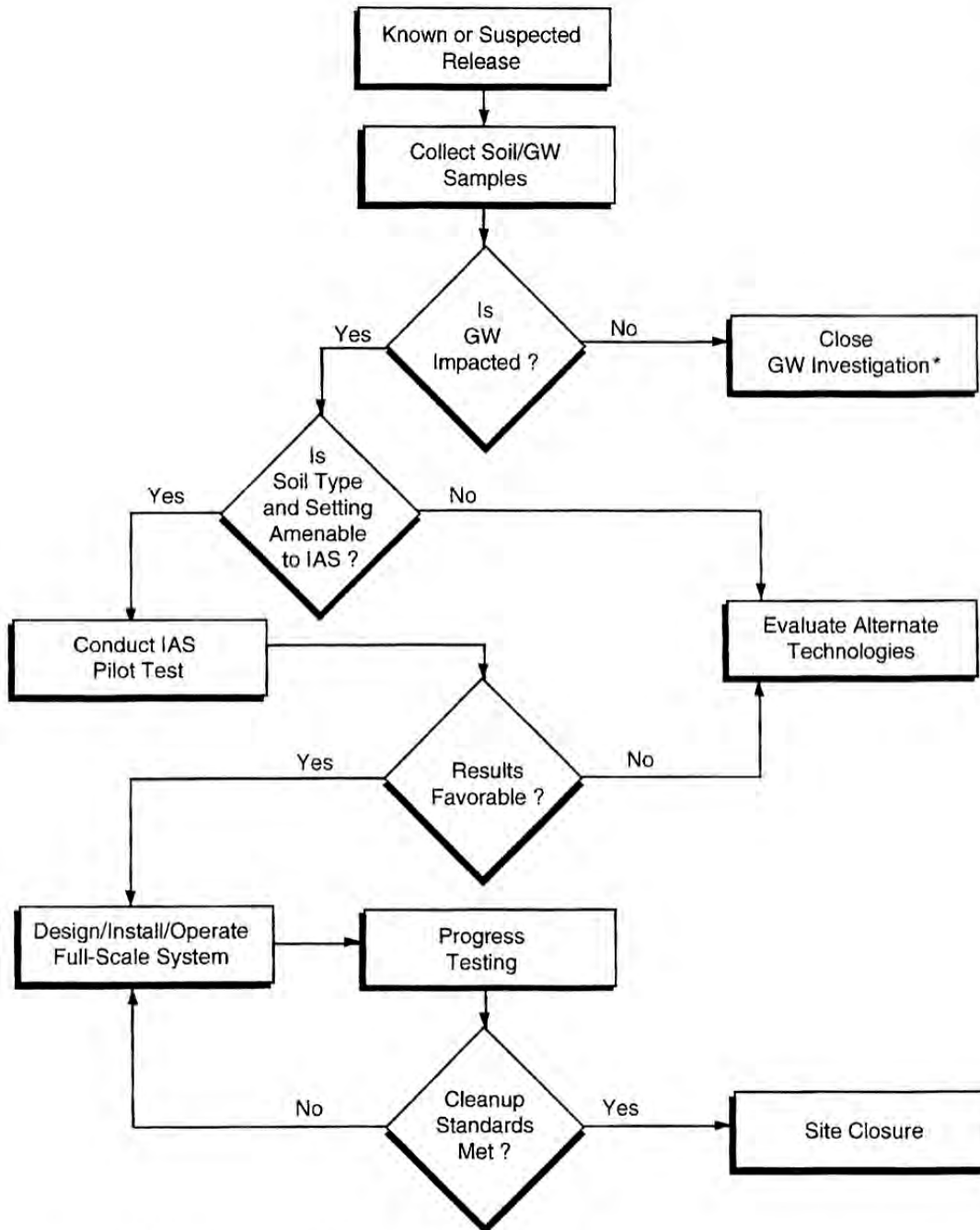

* A leaching assessment for evaluation of groundwater impact may be performed at this point.

Figure 2-9. IAS implementation decision tree.

(7) TOUGH2/TMVOC is also a multi-phase, non-isothermal, saturated and unsaturated numerical transport model that can be applied to IAS simulations. The model is available from the Lawrence Berkeley Laboratory. More information is available at <http://www.esd.lbl.gov>.

d. A limitation associated with IAS models is that the heterogeneities that control airflow paths are on a scale much finer than the available site characterization data. The processes that IAS models must incorporate include multiphase flow, buoyancy and capillary forces acting on air, and soil variability on a small and large scale (perhaps by stochastic methods).

CHAPTER 3

Site Characterization and Feasibility Evaluations

3-1. Introduction. Prior to selecting IAS for implementation, the site characteristics and the nature and extent of contamination must be assessed to evaluate the feasibility of IAS. A suggested strategy for technology screening is presented in this chapter, as well as pre-design data collection requirements and feasibility studies. Critical data requirements include physical, chemical, and biological properties of site media and contaminants.

3-2. Technology Screening Strategy. It is advisable to perform technology screening as early in the process as possible, preferably concurrent with site characterization. Early evaluation of the data needs for remedy selection (and design) may reduce the need for subsequent mobilization to the field during design. Those undertaking technology screening must have a sense of the overall remedial objectives, some knowledge of the nature and extent of contaminants at the site, and a good grasp of the range of technologies available and their limitations. [Figure 3-1](#) presents a decision matrix for IAS technology screening.

a. Remediation Objectives.

(1) At present, although there are many sites at which practitioners have applied IAS, there are relatively few well-documented IAS projects that have attained closure. (The USACE has successfully closed IAS sites at Ft. McCoy, Wisconsin, and the Sacramento Army Depot, California.) Estimates of the amount of time required to operate such systems to completion are inherently uncertain, depending heavily on site-specific conditions and site-specific cleanup goals. The closer initial concentrations are to the target concentrations, the shorter the duration of treatment needs to be. IAS may not achieve Maximum Contaminant Levels (MCLs) at a site, but may be able to reach acceptable cleanup criteria negotiated on a site-specific basis. Guidance for the development of site specific target levels can be found in ASTM E 1739-95 e1.

(2) More intensive operations, such as higher well densities and higher air injection rates, may also reduce remediation time. In general, however, IAS should not be regarded as a rapid technology. Depending on how low the target concentrations must be, one if not several years of IAS may be required at well-suited sites.

(3) The range of contaminant loadings over which IAS has been effective is also not well-defined. It is unclear whether IAS is effective at remediating sites containing large amounts of NAPL (and especially DNAPL); however, it may enhance the final LNAPL removal rate for sites where free-product recovery has been conducted, because of the effects of air movement impinging upon the capillary fringe.

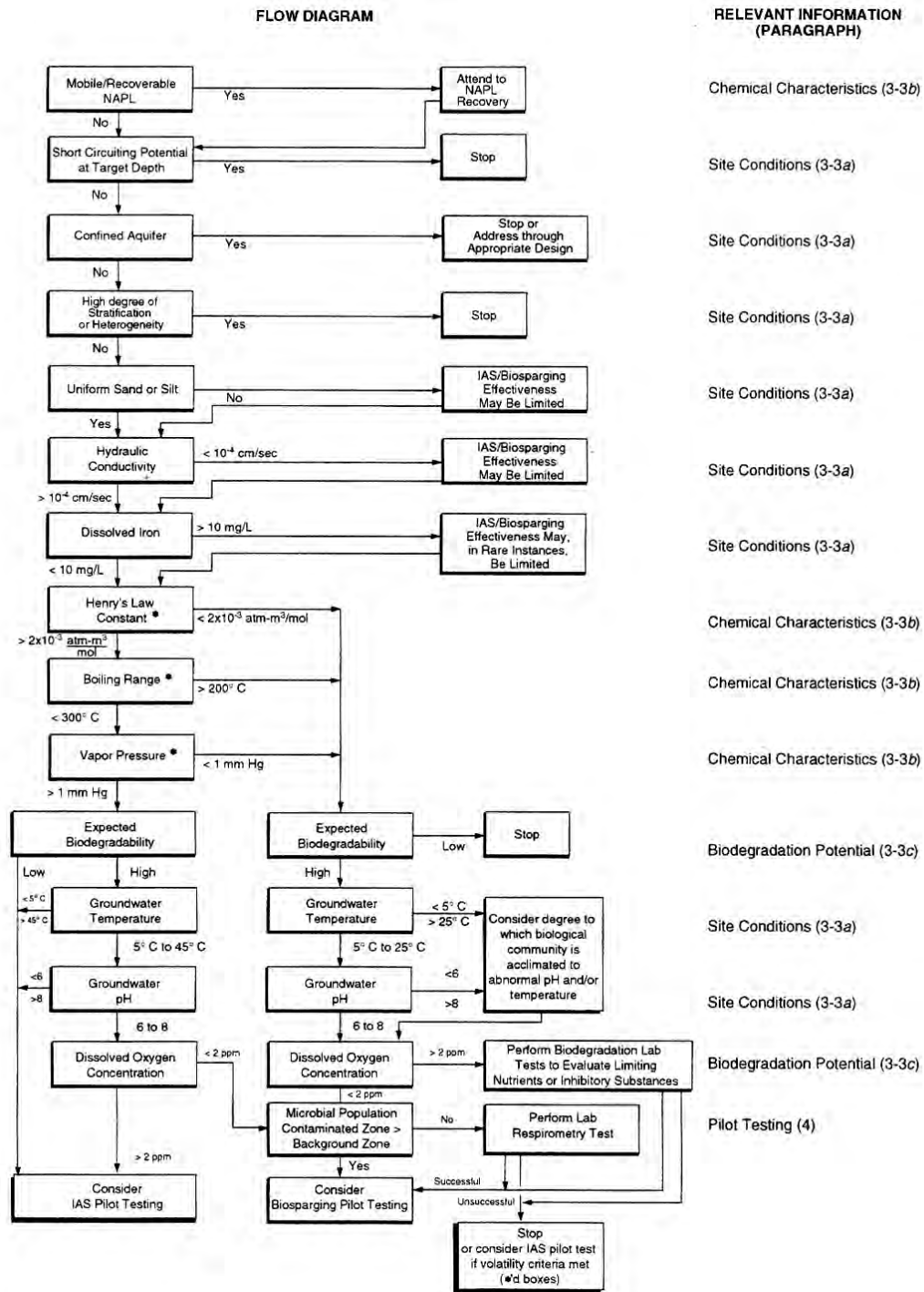

Figure 3-1. Technology screening decision matrix.

b. Influence of Pattern of Contamination on Technology Screening Strategy.

(1) A brief description of a “typical” organic loading profile in the subsurface will help in understanding the remediation objectives that are achievable using IAS, and, therefore, in

conducting technology screening. For most sites where groundwater has been impacted by spilled or released hydrocarbons, they flow through a vadose (unsaturated) zone under the influence of gravity, until they encounter the capillary fringe. Because the water table typically rises and falls owing to seasonal changes or precipitation events, the hydrocarbons become “smeared” across the capillary fringe and the water table (piezometric surface). Much of this mass is occluded in interstitial and pore spaces as small droplets of NAPL, which can only be removed by dissolution in groundwater under normal conditions. This is a very slow process, and is limited by the constituents’ solubility, their diffusivity in water, and the velocity of groundwater movement. The amount of occluded NAPL is affected directly by the distribution of pore and particle sizes within the soil.

(2) A portion of the hydrocarbons that come out of solution below the water table will partition to natural organic carbon (expressed as total organic carbon, TOC). This can add to the depth of the “smear” zone, not uncommonly creating a zone 2.5 to 3 m (8 to 10 ft) in thickness where most of the hydrocarbon is present, whether as small droplets of NAPL or sorbed to the soil. The amount of hydrocarbon actually dissolved in the groundwater is usually less than a few percent of the total hydrocarbon mass. Any process that solely treats the groundwater is thus required to wait for sorbed material or NAPL to dissolve.

(3) Inasmuch as IAS creates flow paths for an immiscible (vapor) phase to move through the water, it may serve as a gentle mixer, potentially accelerating hydrocarbon transport. As IAS also provides oxygen to the groundwater under most applications, the rate of aerobic biodegradation below the water table will also be enhanced. So, while IAS is relatively slow compared to excavation-based approaches, it can be considerably faster than approaches that merely pump water and treat it at the surface. There are sites, however, where pump-and-treat is quite effective and where IAS was ineffective (R.L. Johnson, Personal Communication, 1997).

(4) If IAS is successful mixing the groundwater and increasing hydrocarbon transport, then the groundwater quality may initially deteriorate because of increased contaminant dissolution or mobilization of residual NAPL. These effects will be ameliorated over time, as contaminant mass is removed from the aquifer and remediation proceeds.

(5) Recognizing how NAPL and hydrocarbons, both dissolved and sorbed, are distributed in the subsurface and how they can potentially be affected by IAS processes is a prerequisite to identifying the data collection needs, as discussed in the following paragraphs.

3-3. Pre-Design Data Collection Requirements. Prior to the development of an air sparging design, physical, chemical/biological, and hydrogeologic data are needed. This information will be used to provide insight regarding the feasibility of air sparging as a remediation alternative, as well as providing a basis for the design. These data needs should be considered during the planning process for the site characterization effort (EM 200-1-2, USEPA 2000) and many of the required data can be collected during the investigative phase of the project. Collecting these data prior to conducting the pilot study serves two purposes: 1) it limits the need to remobilize to the site to collect supplementary site data prior to the full-scale design, and 2) the data collected may

be used to guide the design of the pilot test so that the results lead more directly to a successful full-scale design. A series of characterization data parameter lists is presented in Tables 3-1, 3-2 and 3-3. The text in this chapter provides a description of these parameters and their influence on the overall IAS design.

a. Physical Properties and Site Conditions.

(1) The physical characteristics of a site are critical to assessing the feasibility of IAS and subsequently designing pilot- and full-scale systems. In addition to understanding the characteristics of the saturated (i.e., sparging) zone, the characteristics of the vadose zone are also of importance to the performance of IAS. The physical properties of the vadose zone affect the dispersion of gas above the water table and the ability to effectively contain and capture it for treatment, recirculation, or exhaust.

(2) The physical properties of the saturated zone dictate the distribution of injected gas during IAS implementation. Pertinent physical parameters are presented in Table 3-1. Useful chemical and biological property data are discussed in paragraphs 3-3d and 3-3e, respectively. Table 3-1 includes the type of sample required (i.e., collection method) and associated analytical method.

(3) A thorough understanding of site stratigraphy is of the utmost importance. For that reason, at least one borehole shall be continuously logged and representatively sampled to the depth of the deepest sparge well to ensure that a full geological profile is characterized. The personnel responsible for logging the borings shall be instructed to record a detailed and systematic stratigraphic sequence. Even minor changes in soil texture or porosity are significant because they can control air entry and airflow. Visual observations of soil boring characteristics, such as mottling, discoloration, and texture, as well as apparent moisture and grain size, can provide useful information. These observations can indicate groundwater fluctuations, seasonal variations, and hydraulically impeding or confining strata, such as clay lenses.

Table 3-1
Physical Parameters for Soil

Parameter	Sample Type	Analytical Method
Air-phase permeability (of saturated zone soil)	In situ or undisturbed soil sample	Various ¹
Grain size distribution	Split spoon or other soil sample	ASTM D422-63 (1998)
Porosity	Undisturbed 50- to 75-mm diameter soil sample	Calculated from dry bulk density and particle density
Dry bulk density	Undisturbed 50- to 75-mm diameter soil sample	ASTM D2850-03a
Moisture content (of saturated zone soil)	Non-destructive field measurement; grab sample; or undisturbed 50- to 75- mm diameter soil sample	Neutron access tube measurements (Gardner 1986); ASTM D6031-96
Soil moisture retention (capillary pressure-saturation curve); Air-entry pressure	Undisturbed 50- to 75-mm diameter soil sample	Klute (1986); ASTM D2325-68 (2000); Jones et al. (1980)
Stratigraphy/heterogeneity	Soil boring	Visual observation; Breckenridge et al. (1991); USEPA (1991); ASTM D2488-00; EM 1110-1-4000
Depth to groundwater and range of fluctuation; hydraulic gradient and flow direction	Water table monitoring wells	Water level meter or interface gauge and surveyed well elevations; ASTM D4750-87 (2001) (<i>ensure that the probe weight is inert</i>)
Flow paths in saturated soil	In situ field measurement	Groundwater tracer (USEPA 1985)
Hydraulic conductivity	Field measurement	ASTM: D4043-96e1; D4044-96 (2002); D4050-96 (2002); D4104-96; D4105-96 (2002); D4106-96 (2002); D5269-96 (2002); and D5270-96 (2002)
VOCs	Split spoon or probe; sample collected via coring device and preserved with methanol, or syringe-sampler and preserved with sodium bisulfate; stored at 4°C, according to EPA Method 5035	SW 846 Methods EPA SW 8260B, or 8015B or 8021B

¹ EM 1110-1-4001; USEPA SW-846.

Table 3-2
Chemical Parameters for Groundwater

Parameter	Preservative	Analytical Method
Biological oxygen demand (BOD)	4°C	SM 5210B; EPA 405.1
Chemical oxygen demand (COD)	pH <2 with H ₂ SO ₄ ; 4°C	SM 5220D; EPA 410.1
Alkalinity	4°C	SM 2320B; EPA 310.1; field measurement ¹
Total dissolved solids	4°C	SM 2540C; EPA 160.1
Total organic carbon (TOC)	pH <2 with H ₂ SO ₄ ; 4°C	SW 846 Method 9060
Iron (total and field-filtered)	pH <2 with HNO ₃ ; 4°C	SW 846 Method 6010; field measurement ¹
Ammonia-nitrogen	pH <2 with H ₂ SO ₄ ; 4°C	SM 4500; EPA 350.1, field measurement ¹
Total Kjeldahl nitrogen	pH <2 with H ₂ SO ₄ ; 4°C	SM 4500; EPA 351.2
Nitrite and nitrate	pH <2 with H ₂ SO ₄ ; 4°C	SM 4500; EPA 353.2; field measurement ¹
Sulfate	4°C	SW 846 Method 9038
Sulfides	4 drops 2N zinc acetate per 100 ml; pH >9 with 6N NaOH; 4°C	SW 846 Method 9030; field measurement ¹
VOCs	pH <2 with 1:1 HCl; 4°C; no headspace	SW 846 Methods 8260B or 8021B
SVOCs	4°C	SW 846 Method 8270
Total petroleum hydrocarbons (diesel range organics)	4°C	SW 846 Modified Method 8100; field measurement ²
Depth to free NAPL phase	Direct push “soil boring,” e.g., cone penetrometer ³	Laser Induced Fluorescence (USEPA 1997)
pH	None	Field measurement ⁴
Temperature	None	Field measurement ⁴
Dissolved oxygen (DO)	None	Field measurement ^{1, 4}
Conductivity	none	Field measurement ⁴
Redox potential (Eh)	none	Field measurement ⁴

SM is Standard Methods, developed by APHA-AWWA-WEF (www.standardmethods.org); SW 846 is USEPA 1986 and Updates promulgated in 1992, 1994, and 1996.

¹Alkalinity, ammonia, iron (total and dissolved), nitrate, nitrite, sulfides and DO can be determined using field test kits (e.g. manufactured by CHEMetrics® or HACH). Preservation is not applicable.

²TPH (DRO) can be determined in the field using an immunoassay test kit. Preservation is not applicable.

³Readers are advised to check the availability of USACE's cone penetrometer units for their projects ([paragraph 3-3b\(3\)](#)).

⁴Temperature, DO, conductivity and Eh can be determined in the field using appropriate field instruments.

Table 3-3
Useful Physicochemical Properties

Chemical's Physical Property	Typical Units	Significance
Molecular (formula) weight	g/mol	Chemicals tend to be more volatile as their molecular weight decreases.
Liquid density	g/cm ³	Chemicals greater than or equal to 1 g/cm ³ tend to form DNAPL if their solubility in water is exceeded; chemicals less than 1 g/cm ³ tend to form LNAPL if their solubility in water is exceeded.
Vapor pressure	mm Hg	Chemicals greater than 1 mm Hg are considered volatile (USEPA 1995a).
Solubility in water	mg/L	The presence of NAPL should be suspected if aqueous concentrations exceed 1% of a chemical's solubility in water (Newell and Ross 1991).
Octanol/water partitioning coefficient (K_{ow})	dimensionless	A higher value indicates a chemical will preferentially dissolve in (partition into) an organic phase.
Organic carbon partitioning coefficient (K_{oc})	dimensionless	A higher value indicates a chemical will preferentially adhere to (partition into) organic material in soil. The extent of partitioning will depend upon the chemical's K_{oc} and the soil's f_{oc} . The more a chemical partitions into soil organic matter, the less effective IAS will be at stripping the chemical from the saturated zone.
Henry's law constant (K_H)	atm-m ³ /mol, L-atm/mol, or dimensionless	A higher value indicates a chemical will preferentially transfer from an aqueous to a gaseous phase. K_H values greater than 2×10^{-3} atm-m ³ /mol are considered to indicate that IAS may work. IAS may not be appropriate for compounds with K_H values less than 2×10^{-3} atm-m ³ /mol (USEPA 1994). Appendix B provides a table of Henry's Law constants for some common compounds. However, the success of biosparging is generally not dependent on K_H values.
Redox potential ¹	volts	A higher value indicates a chemical will be reduced, rather than oxidized when coupled in a redox reaction.

¹Redox potential for a given oxidation/reduction half-reaction (e.g., $Fe^{3+} + e^- \rightarrow Fe^{2+}$).

(4) In addition to collecting soil samples for analyses of physical properties, a review of available site maps and visual inspection is recommended to better understand the site at which IAS is being considered. The presence and structure of building foundations, basements, reinforced earth, subsurface utilities and drainage structures, existing monitoring wells, soil gas monitoring points, soil borings, filled excavations, and surface paving materials may affect the operation of an IAS system.

(5) Subsurface structures in the vadose zone may alter the distribution of airflow generated during IAS and result in uncaptured offgas or vapor intrusion into buildings if left uncontrolled. For sites where little or no surface paving exists (i.e., soil or gravel surfaces), it may be difficult to capture offgas for controlled treatment, recirculation, or exhaust. Further, subsurface zones of enhanced permeability (e.g., a gravel pipeline trench or backfill or improperly abandoned soil borings and monitoring wells screened across the water table) can cause preferential channeling of air flow and limit the effective ZOI. Not only would preferential pathways reduce the interstitial air/water surface area, but the majority of subsurface contaminants may be bypassed in the event of sparsely distributed channels. Similar influences exist within the saturated zone. For example, improperly abandoned soil borings or monitoring wells can cause preferential migration of air pathways both below and above the water table surface. By properly assessing the physical conditions and heterogeneity of the subsurface prior to implementing IAS, these occurrences can be minimized or avoided.

b. Soil Sample Collection. Representative undisturbed soil cores shall be collected and submitted for physical parameters analysis from every major stratigraphic unit between the seasonal high water table elevation and the anticipated lowest elevation of sparge screens. Undisturbed soil samples are typically collected using Shelby-tube samplers. Samples should be collected from depth-discrete intervals for acquisition of data from various stratigraphic layers. In conditions where cobbles and boulders impede the ability to push Shelby tubes into the subsurface, representative cores may not be obtained unless a technique such as Roto Sonic[®] drilling is employed. Roto Sonic[®] drilling is an innovative vibratory dual-tube direct push method that has proven capable of collecting intact cores while achieving high penetration rates in a wide range of conditions.

(1) It is sometimes difficult to collect undisturbed samples from the saturated subsurface with Shelby-tube samplers, because wet, non-cohesive soil may not be retained in the sampling device. Lined split-spoon samplers are recommended in this situation. When using a split-spoon sampler, brass or stainless steel liners tend to provide a more watertight seal than acetate liners. Once samples are brought to the surface, plastic end caps and end packers are effective in capping the ends of a liner prior to transport. It should be noted that the density of soil within the split-spoon liner will likely be greater than the true in-place density because of compression while advancing the split-spoon. To collect a relatively undisturbed sample in saturated sands, a 1.5-m continuous core barrel sampler (i.e., liner) placed inside the auger is recommended. In the event that soft cohesive or non-cohesive soils are encountered, equipment such as the Waterloo sampler, which uses a piston plug to create a vacuum on the sample barrel, helps ensure that saturated sands remain within the core barrel during sampling.

(2) A detailed discussion of the effect of physical characteristics on subsurface air flow is contained in EM 1110-1-4001. Soil parameters that have effects that are specific to IAS are discussed below.

(3) Porosity and permeability affect the degree of groundwater mounding and upwelling that may occur during pilot-scale testing and IAS implementation. Generally, the degree of mounding and upwelling is smaller under conditions of high subsurface porosity and permeability. Mounding, upwelling, and other potential start-up occurrences are further discussed in [paragraph 2-7a](#).

(4) Soil moisture retention data ([Table 3-1](#)) provide a means to determine the air-entry pressure of a given soil. A soil's air-entry pressure is a critically important property for IAS. More detail on the importance of air-entry pressure is provided in [paragraph 2-6](#). Descriptions of the method of measuring air-entry pressure and interpretation of the measurements are provided below.

c. Moisture Retention Analysis for Determining Air-Entry Pressure. Moisture retention analysis (ASTM D 2325) is a laboratory procedure that involves the stepwise application of a pressure differential to an initially saturated soil sample, with the equilibrium moisture content measured at each step. The first step involves application of the lowest (e.g., 33 mbar) pressure step to the sample, which induces drainage of water from the largest pores of the sample until equilibrium is approached at that pressure, at which time the sample is weighed to determine the volume of water desorbed from those pores. Then the next higher pressure is applied, inducing drainage from the next smaller class of pores, and re-equilibration is allowed to occur, followed by reweighing. The process thus proceeds in a stepwise fashion, until the sample is virtually dry.

(1) The resulting data are plotted in the form of capillary pressure head as a function of saturation (or equivalently, matric suction as a function of moisture content). A minimum of seven separate pressure points is recommended to ensure that the curve encompasses the most crucial moisture characteristics.

(2) [Figure 3-2](#) presents data from moisture retention analyses, expressed as capillary pressure head vs. moisture content, for adjacent soil cores collected from the same soil boring. The shallower, siltier sample ([Figure 3-2a](#)) has an air-entry pressure head of approximately 370 cm H₂O, while the air-entry value for the deeper, sandier sample ([Figure 3-2b](#)) is approximately 36 cm H₂O. Clearly, if the IAS screen intercepted both soil layers, air entry would occur into the deeper horizon first; air might not enter the shallower horizon at all.

d. Chemical Analyses. During site characterization, the chemical properties of site media and the nature and extent of contamination must be assessed to evaluate the feasibility of IAS. As discussed in [paragraph 2-11](#), contaminants generally amenable to IAS are VOCs, including the lighter fuels (e.g., gasoline, diesel, and jet fuel) and petroleum-related compounds, as well as cleaners, solvents, degreasers, and associated chemicals. In addition to the partitioning and removal of VOCs through stripping, IAS can be used to enhance or induce other contaminant

transfer mechanisms, such as precipitation and biodegradation. As such, it is critical to acquire sufficient chemical data to fully assess the potential for the desired IAS mechanisms. A list of relevant groundwater chemical parameters is presented in [Table 3-2](#).

(1) Field Screening. A variety of field screening techniques are available for the preliminary assessment of site media. Readily available portable organic vapor analyzers include photoionization detectors (PIDs) and flame ionization detectors (FIDs). These devices provide an indication of the total organic vapor in ambient air or within the headspace of boreholes or sampling containers by comparing the vapor reading of the sample to the calibrated value of a specific compound, for either the photoionization potential of a specific lamp energy (for PIDs) or a flame ionization potential (for FIDs). If specific vapor-phase chemicals are of interest, direct-reading colorimetric indicator tubes, such as Draeger[®] tubes, provide useful data that may be correlated with gas chromatograph/mass spectrometry (GC/MS) analyses (NIOSH 1985).

(a) One commonly applied method of field screening for VOCs is a soil gas survey. VOCs amenable to IAS are also generally amenable to field soil gas measurement. Soil gas surveys are useful in assessing the relative concentrations of the VOCs of interest and related compounds, as well as oxygen, carbon dioxide, and methane. The concentration of total organic vapor in soil gas can be used to estimate the initial concentration in the IAS vapor emissions. Soil gas surveys can also be instrumental in locating the soil contamination and guiding the placement of IAS and SVE wells.

(b) Soil gas surveys can be misleading, however. For example, soil gas concentrations of specific chemicals often do not usually correlate well with laboratory analyses of soil samples. Soil gas surveys measure chemicals in the vapor phase at a given spatial point. Advection attributable to barometric pumping can cause vapors to travel and be detectable at a distance from source areas. Conversely, “hot spots” identified by laboratory analysis of soil samples may be present in low permeability portions of a site that are not conducive to vapor transport and, therefore, may not be detected during a standard soil gas survey. Thus, there is no consistent relationship between the presence of vapor-phase VOCs at a survey point and the distance from which the VOCs originally emanate (Downey and Hall 1994). Chemical-specific results of field soil gas measurements are best viewed as screening data, depicting general locations of increased vapor-phase VOCs in the vadose zone.

(c) The shallow subsurface migration of vapor-phase VOCs (revealed by areas of increased soil gas concentrations) may be used to predict the migration of future VOCs that will be generated during IAS. This information is useful in selecting locations for confirmatory soil and groundwater samples, as well as the placement of SVE components (if required).

(d) Vapor-phase VOCs are typically measured with a gas chromatograph equipped with an FID, PID, electron capture detector (ECD), or MS detector. Methods typically employed for collection of soil gas are listed below. In general, Standard SW 846 methods apply (USEPA 1986).

- Adsorption onto a sorbent medium, such as charcoal, Tenax[®], or Ambersorb[®], followed by thermal or solvent desorption.
- Cryogenic trapping.
- Collection in canisters or Tedlar[®] bags followed by direct injection onto the GC.

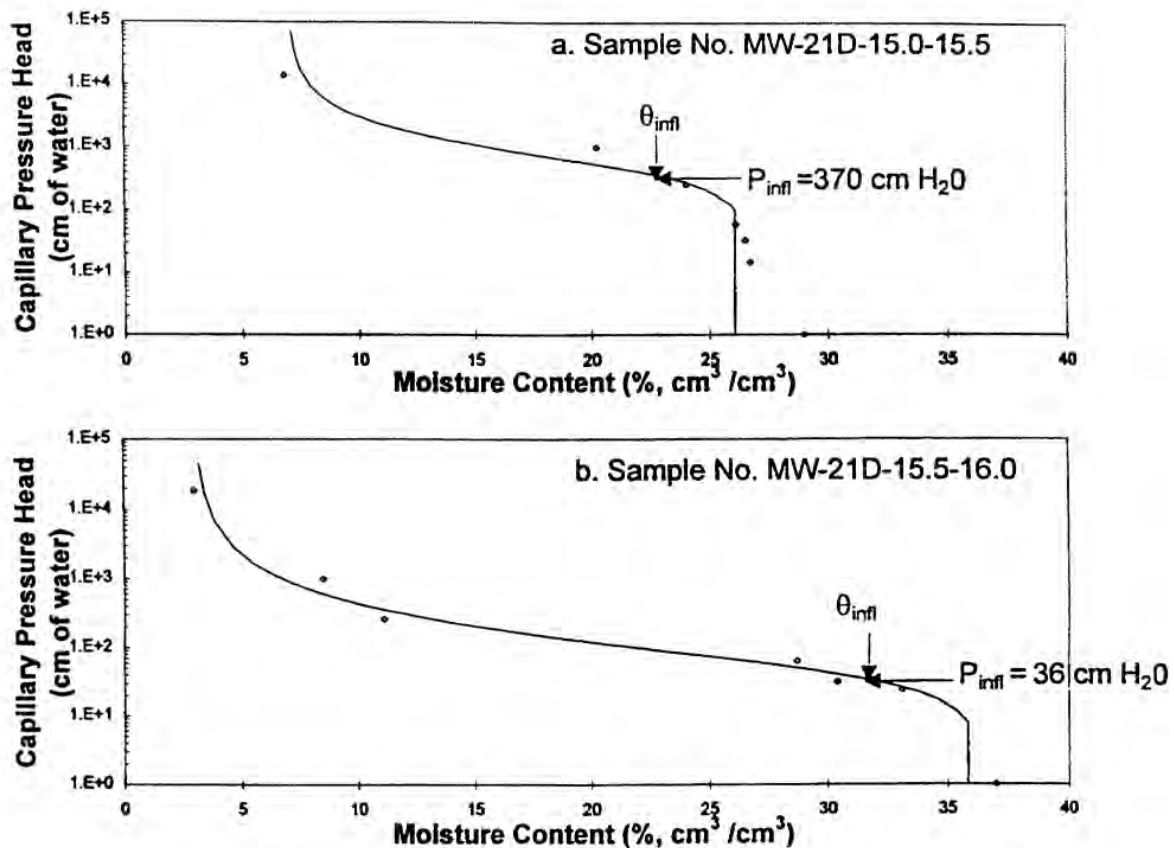

Figure 3-2. Capillary pressure head vs. moisture content for two adjacent soil horizons. Intact cores collected from adjacent soil layers within the sparge zone were submitted for laboratory analysis (data points); curves are Van Genuchten (1980) functions fitted to the data. The Inflection points (P_{infl}) were found to correspond closely to the air entry pressure measured during IAS. The sharp contrast in entry pressures suggests that sparged air flows preferentially within the deeper sandier layer, and does not even enter the shallower, siltier layer (Baker et al. 1996)

(2) Chemical Characteristics of Groundwater. Groundwater samples must be analyzed to assess the presence and concentrations of target VOCs and associated chemicals, as well as the presence of potential IAS inhibitors. Chemical inhibitors of IAS include toxins that may impede the growth of microorganisms and subsequently the biodegradation rate. Additionally, inorganic compounds may precipitate when oxidized or excessive biomass may agglomerate, both of which can cause clogging of well screens. The presence of inhibitors does not necessarily preclude the

application of IAS, but rather creates a potential operating problem that must be anticipated and accounted for in the IAS design.

(a) Relatively high concentrations of iron (greater than 10 mg/L) may become oxidized and precipitate when aerobic IAS is implemented (USEPA 1995a, Wisconsin DNR 1993, Marley and Bruell 1995). These documents advise that well screens may become clogged by precipitated iron or by iron reducing bacteria, gradually reducing the subsequent ZOI of the IAS system. It has been observed, however, that fouling of IAS wells is rarely a problem, because sparge wells are essentially continuously being developed by the injected air. IAS has been conducted successfully at dozens of sites with high iron levels (D.H. Bass, Personal Communication, 1997). Where concerns remain, geochemical models, such as MINTEQA2[®], may aid in predicting the potential precipitation of iron and other dissolved metals detected in the subject aquifer, as well as buildup of iron bacteria at well screens. An additional discussion of biofouling is provided in [paragraph 6-4\(a\)](#).

(b) Chemical groundwater parameters useful in assessing the feasibility of IAS are summarized in [Table 3-2](#). Useful physical and biological property data are discussed in [paragraphs 3-3a](#) and [3-3e](#), respectively. [Table 3-2](#) includes the preservatives required for the analytical methods referenced. Polyethylene or glass sample containers are used depending on the specific test parameter. Generally, 40-mL glass VOA vials with Teflon[®] septa are required for samples collected for VOC analyses. Standard SW 846 methods apply (USEPA 1986).

(c) Several methods are available for collecting groundwater samples. The methods typically implemented require either a semi-permanent sampling location, such as a groundwater monitoring well and low-flow, low-purge sampling (Puls and Barcelona 1996, ASTM D6771-02), or a temporary sampling location, such as can be accomplished using direct-push technology (DPT). DPT methods include Geoprobe[®], Terraprobe[®], MicroWell[®], SimulProbe[®] and Hydropunch[®], some of which are capable of being purged through inertial bailing and are therefore able to provide a representative sample of formation water at a point in the aquifer. DPT methods are typically used to yield chemical results from vertically discrete locations, which can help develop a more accurate three-dimensional “picture” of site contamination and geochemistry than generally available from groundwater wells. DPT groundwater sampling methods should be used in conjunction with soil sample collection to minimize sampling costs. However, semi-permanent groundwater monitoring wells are more cost-effective where groundwater is repeatedly sampled from the same location. The vertical positioning of groundwater monitoring well screens (screened interval) should be carefully planned to ensure that the data obtained from a given well can be used to interpret the areal and vertical groundwater chemistry. Groundwater well screens are often 3 m or more (10 ft or more) long. However, when wells with such long well screens are sampled, water can be collected from above or below the plume in addition to the water from within the plume. When this occurs, the resulting water quality measurements may reflect a mixture of clean oxygenated water with anaerobic contaminated water. Thus, the degree of oxygenation within the plume can be obscured. Consideration should be given to installing several nested wells with 0.6-m (2-ft) well screens in such locations to maximize the resolution of the groundwater results.

(d) It must be noted that IAS operational data (as opposed to site characterization data) acquired through monitoring wells may not represent true subsurface conditions (Johnson et al. 1993). Because of potential gas transfer within the well itself (“in-well aeration”), oxygen concentration measurements from the well may not be representative of the groundwater surrounding it. Figure 3-3 (Hinchee 1994) illustrates how air channeling to a monitoring well can cause the groundwater samples to have higher than representative DO and lower than representative VOC concentrations (Johnson et al. 1995).

(e) In addition to dissolved groundwater contaminants, the presence or potential presence of NAPL must be assessed. NAPL can be present as either a light phase, less dense than water (LNAPL), or a heavy phase, more dense than water (DNAPL). Where both types of compounds are present at a site, mixtures of the two are common, and the tendency of the NAPL to float or sink depends on the density of the resulting mixture.

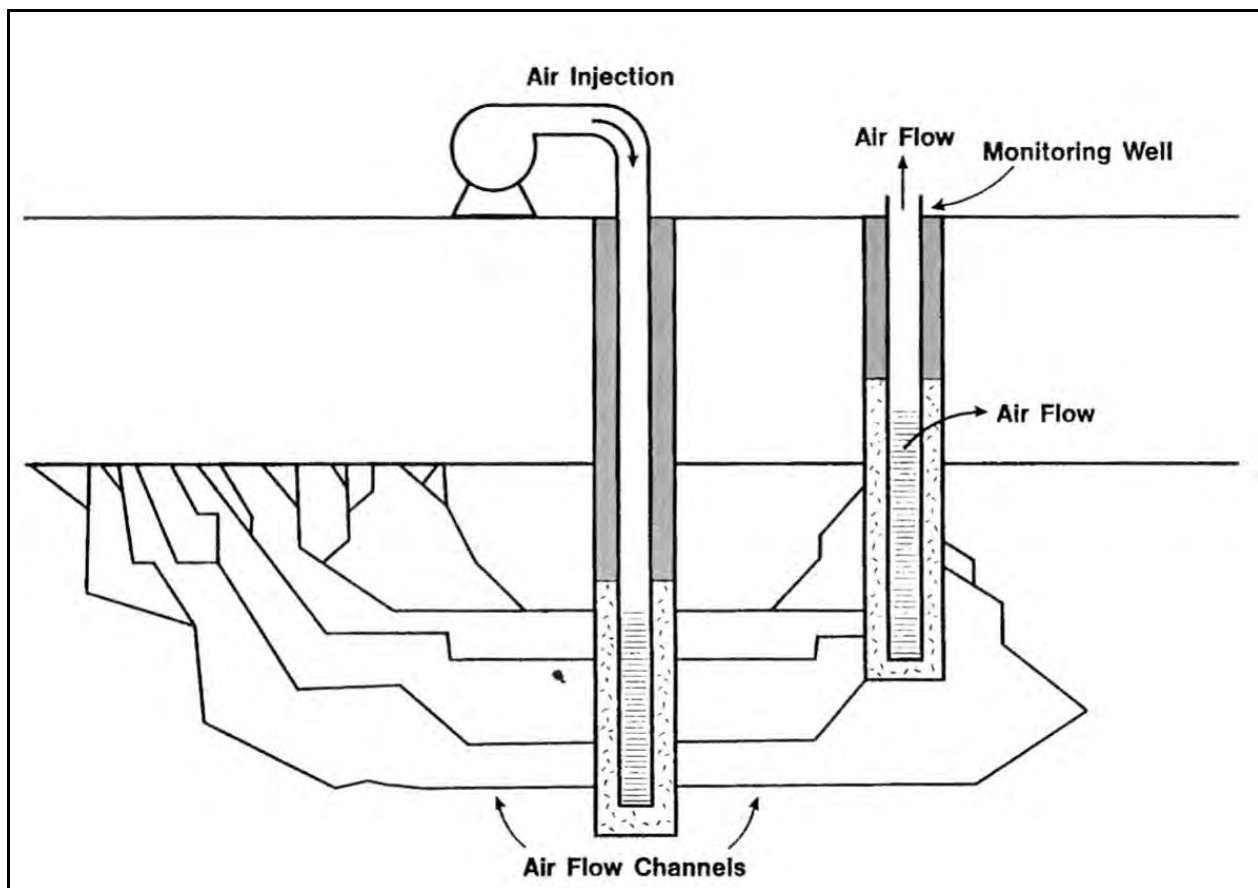

Figure 3-3. Cross section of IAS application illustrating air channeling to a monitoring well (from Hinchee 1994; reprinted with permission from *Air Sparging for Site Remediation*; copyright Lewis Publishers, an imprint of CRC Press, Boca Raton, Florida; ©1994).

(f) Because LNAPL and groundwater are immiscible fluids, LNAPL can be distributed within the capillary fringe above the groundwater table. LNAPL observed in a piezometer or

monitoring well represents its apparent thickness. Several empirical and analytical relationships exist to convert the apparent thickness of LNAPL to the true thickness present in the subsurface formation (Testa and Paczkowski 1989, Farr et al. 1990, Lenhard and Parker 1990). Common parameters required to arrive at these relationships are listed below:

- Fraction of pore space in the formation, i.e., porosity.
- Fraction of pore space occupied by LNAPL, i.e., oil saturation.
- Specific gravity ratio of LNAPL to groundwater.
- Fraction of the pore space occupied by recoverable LNAPL, defined as the difference between oil saturation and residual oil saturation.
- Air/water capillary pressure-saturation relationship for the soil(s) of interest.

(g) Although some practitioners have observed that LNAPL sites respond well to IAS, it is not likely to be successful if there is a significant volume of recoverable LNAPL. The utility of IAS in the presence of substantial layers of LNAPL is a matter of ongoing research.

(h) The extent and volume of LNAPL must be delineated prior to proceeding with IAS. The displacement that occurs during the startup of IAS systems may assist in upward mobilization of LNAPL trapped below the water table by groundwater fluctuations. It is generally recommended that free-phase LNAPL within an IAS ZOI be removed via a passive or active recovery system prior to the IAS system startup.

(i) The extent to which the presence of DNAPL may influence the performance of IAS is uncertain. IAS may be useful in creating the subsurface agitation necessary to break up and dissolve pockets of DNAPL. However, identifying the presence of DNAPL prior to proceeding with IAS is not a trivial problem. DNAPL may significantly delay or impede the ability to achieve dissolved phase cleanup objectives. Additionally, IAS may potentially spread the immiscible liquid outside the ZOI or force it into deeper strata. For that reason, application of IAS to DNAPL-contaminated strata that overlie uncontaminated aquifer units is not recommended unless there is confidence that an intervening aquitard will prevent downward migration. Containment is generally the recommended approach for DNAPL sites that lack such an aquitard.

(3) Chemical Characteristics of Soil. Subsurface soil samples must be analyzed to assess the presence and concentrations of target VOCs and associated chemicals. For most soil strata impacted by hydrocarbons, the majority (often a large majority) of the hydrocarbon mass is sorbed to the soil particles or resides as NAPL within interstitial spaces. Soil concentrations provide the most useful assessment of how much material will actually require removal or degradation.

(a) Chemical soil parameters useful in assessing the feasibility of IAS are listed below. Useful physical and biological property data are discussed in [paragraphs 3-3a](#) and [3-3e](#), respectively.

- Specific VOC concentrations.
- Total Organic Carbon (or foc—fraction organic carbon).
- Ammonia-nitrogen.
- Total Kjeldahl nitrogen.
- Nitrite and nitrate.
- Ortho-phosphates.
- Total phosphates.
- pH.
- Sulfates.
- Sulfides.

(b) Polyethylene or glass sample containers are used depending on the parameter of interest, and usually a temperature of less than 4°C must be maintained during transport. Generally, 4-oz wide-mouth glass jars with Teflon[®] septa are required for samples collected for soil VOC analyses, but in some cases, other glass containers may be acceptable. Standard SW-846 methods apply (USEPA 1986).

(c) Several methods are available for collecting soil samples. Analyses for chemical data do not typically require that the samples be undisturbed. However, VOCs are often lost through evaporation during conventional soil sampling (Siegrist and Jenssen 1990, Hewitt 1994). A variety of sampling methods are available for collecting undisturbed samples. Methods typically used include acquiring samples during borehole drilling, as well as DPT sampling devices. With these methods, it is imperative that samples be collected from depth-discrete intervals to differentiate among subsurface strata. For example, the groundwater interface may provide a more aerobic (i.e., oxygenated) environment than deeper strata.

(d) Split-spoon samplers (generally 5-cm [2-in.] diameter, 60-cm [2-ft] length) are frequently used to collect depth-discrete samples while advancing hollow-stem augers in a borehole. DPT methods include Geoprobe[®], Terraprobe[®], SimulProbe[®], and MicroWell[®]. These and other related DPT methods generate data of comparable quality to traditional methods (i.e., split-spoon samplers), but may not be as successful in recovering samples if the soil is very coarse, or if the sampling depth is more than 15 m (50 ft). Cone penetrometers and sonication drilling rigs (e.g., Roto Sonic[®] drills, [paragraph 3-3b](#)), by contrast, can produce soil characterization data to significantly greater depths. Use of the Triservice Site Characterization and Analysis Penetrometer System should also be considered.

(4) Physical Properties of Chemicals. The physical properties of target chemicals detected in site media provide useful information related to the feasibility of IAS. The physical properties of chemicals not directly detected, but which could be created through oxidation, biodegradation, or other transformation processes, should also be identified. Physicochemical properties required

for detected and potential chemicals are listed in [Table 3-3](#). Perhaps the most critical physical property of a chemical that will indicate the potential success of IAS is the chemical's Henry's Law constant. This parameter indicates the tendency of the chemical to partition into air from water. The higher the Henry's Law constant is, the more successful IAS will be at stripping a compound from the water phase into the air phase. [Appendix B](#) provides a table of Henry's Law constants for some common compounds that may be considered for an IAS remedy.

(5) Relationship among Chemicals. Chemical data can be used to assess the potential suitability of IAS. Field measurements of pH, dissolved oxygen, and redox potential in groundwater (shallow and deeper zones) are generally useful in assessing whether aqueous conditions tend to be aerobic or anaerobic, and the extent to which they vary with depth. Laboratory analyses of BOD and COD indirectly indicate the amount of biologically and chemically oxidizable material present. Elevated BOD and COD measurements indicate that a relatively elevated oxygen demand exists, either organic or inorganic in nature. If there is a significant amount of readily oxidizable material present that is non-target, then it may account for much of the oxygen uptake associated with IAS.

(a) Laboratory analyses of nitrogen and sulfur compounds are useful in verifying whether subsurface conditions tend to be reductive or oxidative. Analyses of iron (total and field-filtered) further indicate the presence of either reductive or oxidative conditions.

(b) Target organic chemicals (e.g., TCE) can be compared to concentrations of related compounds (e.g., cis- and trans-1,2-dichloroethene; VC). The presence of related compounds can be the result of releases of these compounds, impurities in the target compound, or natural subsurface transformation. Common transformation processes that can create related compounds include oxidation/reduction, biodegradation, hydrolysis, and elimination reactions.

(c) Combined with data obtained from biological analyses ([paragraph 3-3e](#)), the appropriate chemical data can be used to assess the nature and degree of microbial activity, and support the design of an appropriate IAS system.

(6) Data Validation. Prior to using chemical data for decision-making, some degree of data validation should be done. In most cases, full validation in accordance with formal USEPA protocols is not required for site characterization or pilot-scale data related to the implementation of IAS (refer to EM 200-1-6). However, if comparisons to cleanup criteria are intended, full validation is recommended. At a minimum, data received from an analytical laboratory should be qualitatively assessed. Consideration should be given as to whether holding times and sample preservation requirements were met. A cursory review of chemicals detected in duplicates and blanks, as well as the percentage of surrogate recoveries in matrix spike samples, provides an indication of the quality of analytical data received. The Quality Assurance Project Plan (QAPP) must include appropriate quality control samples, such as duplicates, matrix spikes, field and trip blanks at specified frequencies, usually as a percentage of the total number of samples collected.

e. Evaluation of Bioremediation Feasibility. For most sites, the potential removal of organics by microbial degradation (e.g., biosparging) depends on a variety of factors, the most important of which are listed below. The order of importance will depend on the site-specific conditions.

- (1) Amenability of site contaminants to biodegradation.
- (2) Presence of microorganisms acclimated to the site contaminants.
- (3) Presence of toxic or inhibitory constituents (organic and inorganic).
- (4) Oxygen (or other electron acceptor) availability or ability to supply at needed rate.
- (5) Nutrient availability or ability to supply at needed rate.
- (6) Temperature.
- (7) pH.

f. Feasibility of Biosparging. The feasibility depends on all of the same parameters as IAS (e.g., solubility, soil permeability, foc, soil homogeneity), except the contaminants' volatility. Contaminants that are amenable to biodegradation, but not volatile enough to consider stripping from saturated soil (e.g., naphthalene), may be treated by biosparging. Therefore, determining the feasibility of biosparging requires the same assessment as for IAS, with the additional factors listed above. Microorganisms generally will utilize oxygen delivered via IAS until the hydrocarbons are no longer bioavailable. Therefore, it may be more important to focus on how much oxygen can be delivered, and how well distributed it will be, than to determine degradation rates per se. The real utility of bench-scale biodegradation tests is to verify that there is no site condition that will limit or inhibit biodegradation.

(1) Biodegradability. The biodegradability of most common site contaminants have been evaluated many times in both the laboratory and field. For many light to medium weight fuel constituents (e.g., gasoline to #4 fuel oil), typical degradation rates are available in the literature. Published values are very site specific or may reflect a large range of degradation rates, and, thus, care should be used in extrapolating biodegradation rates for a given site. However, published values are useful for qualitatively assessing the feasibility of biodegradation at a site. The factors that can decrease the degradability of the constituents include concentration (e.g., attributable to toxicity effects), and time elapsed since contaminants were released into the environment. Typically, after petroleum hydrocarbons infiltrate into the subsurface, the proportion of recalcitrant constituents will increase with time.

(2) Bacterial Population Densities.

(a) In most cases, characterization of the number of bacteria is not required at sites contaminated with readily aerobically degradable compounds, unless there are circumstances that suggest limitations to bacterial growth. If oxygen is clearly limiting biological activity, as indicated by depleted dissolved oxygen levels in ground water (i.e., measured dissolved oxygen is less than 1 mg/L), and there is no evidence that bioavailable nutrients are not available in

aquifer soils, then it can usually be assumed that the microbial community can be stimulated by air sparging. As such, the enumeration or characterization of bacteria communities is not recommended at most sites.

(b) The presence of a high population density of bacteria in contaminated, saturated soil generally indicates conditions that can accommodate bioremediation. However, small population densities of bacteria do not necessarily mean that bioremediation is infeasible, but rather that existing conditions are not favorable for promoting bacterial growth. If there are low bacterial population densities, it is important to consider whether there are subsurface conditions limiting bacterial activity that may be manipulated during remediation. For example, in an aquifer contaminated with petroleum, there may be little or no dissolved oxygen (i.e., < 1 mg/L) and relatively low population densities of aerobic heterotrophic (organic carbon metabolizing) bacteria and aerobic contaminant-specific degrading bacteria. However, upon introduction of dissolved oxygen through biosparging, population densities of aerobic bacteria may increase rapidly by utilizing the available oxygen for biodegrading (i.e., metabolizing) the petroleum compounds. Similarly, an aquifer lacking another limiting nutrient, such as available nitrogen, may have relatively low population densities of bacteria but may be suitable for bioremediation if growth is stimulated by delivering this nutrient.

(c) Comparing bacterial population densities of background and contaminated zones provides additional insight into the feasibility of bioremediation. If there are significantly greater numbers of either heterotrophic or specific contaminant degraders present in the contaminated zone, then there is evidence that the bacteria in the contaminated zone may be capable of biodegrading some (or all) of the contaminants. Again, the converse does not necessarily demonstrate that bioremediation is infeasible, but that there may be some factor inhibiting bacterial growth.

(d) There are a variety of methods for estimating the population densities of both total heterotrophic and specific contaminant degrading subsurface microbes, including plate counts, Most Probable Number (MPN), phospholipid fatty acid analysis, enzyme activity analysis, and ATP bioluminescence assays. Plate counts and MPN methods are the most frequently used.

(e) With plate counts, site soil is added to a nutrient rich agar medium in Petri dishes, incubated, and then the number of separate colonies grown (Colony Forming Units or CFU) are counted. Plate counts of specific contaminant degraders (i.e., native bacteria that can use the contaminant as a sole source of carbon) use a medium containing one or more of the organic contaminants, such as gasoline or naphthalene, as the sole carbon source. When population densities are estimated by plate counts, they are typically expressed as exponential numbers, such as 2×10^6 CFU/g soil. MPN tubes are the most common alternative to plate counts. Site soil is added to tubes of media in which growth can be detected by color change, gas generation, turbidity, or other means. The numbers from these two methods are not directly comparable (i.e., 5×10^5 CFU/g is not the same as 5×10^5 MPN/g).

Table 3-4
Microbiological Tests and Typical Results

Test Description	Typical Initial Results	Typical Highest Results	Comments
Total heterotrophic bacteria (plate or MPN)	1000–10,000 (10^3 – 10^4) CFU/g	10^8 – 10^{10} CFU/g	Microbes which use organic carbon
Hydrocarbon degraders (plate or MPN)	1000–10,000 (10^3 – 10^4) CFU/g	10^6 – 10^8 CFU/g	Microbes that use the target range of hydrocarbon compounds
Specific compound degraders	100–1000 (10^2 – 10^3) CFU/g	10^5 – 10^6 CFU/g	Microbes that use specific target compounds (e.g., naphthalene)

(f) Various laboratories and companies who specialize in bioremediation have laboratory methods to conduct these tests. There are accepted standard methods for sewage and water quality (APHA/AWWA/WEF 1992) but no universally accepted methods for wastes and hazardous wastes. Methods shown in the above reference may be modified to use for environmental remediation, and such modified methods may be used to assess microbial activity. Methods of Soil Analysis, Part 2, Chemical and Microbiological Properties, 2nd Edition (Page et al. 1982) also includes methods for microbial activity testing. The results of these tests are most meaningful when compared with other results from the same site to indicate the potential to use IAS to enhance biodegradation. The methods and typical expectations are presented in [Table 3-4](#).

(3) Laboratory Biodegradation Tests.

(a) In addition to testing soil or groundwater samples, or both, to monitor microbial activity, laboratory tests may be used to evaluate the feasibility of bioremediation. Biodegradation rates may also be measured under controlled, laboratory conditions, though these rates are not likely to represent field in-situ degradation rates. For contaminants that consistently have been demonstrated to be aerobically biodegradable, such as gasoline, laboratory biodegradation tests are generally unnecessary and are not recommended. However, possible reasons for doing these tests for known-to-be biodegradable contaminants include the following.

- Determination of the presence of a toxic constituent in the soil.
- Identification of mineral nutrient limitations (e.g., nitrogen or phosphorus).
- Demonstration that the proposed treatment approach is viable.

(b) Biodegradation tests are also useful for evaluating contaminants whose biodegradability is unknown, or that are recognized to be biodegradable but are considered to be recalcitrant. Two common laboratory degradation tests are shake flask tests and respirometry tests. Shake flask tests are generally conducted on a slurry of site soil in site groundwater and measure the rate of

disappearance of the contaminant under controlled conditions. Respirometry tests measure oxygen utilization and carbon dioxide production.

(c) Shake flask or microcosm tests are usually composed of a series of flasks, usually at <25% solids, that are subject to different test conditions that test the effects of various amendments and other parameters on the degradation process. The flasks are shaken or stirred to provide aeration and mixing. This approximates the addition of air to the subsurface. If nutrient amendment is being considered, then the nitrogen and phosphorus levels in the soil and groundwater may be used to determine the levels of nutrients to add (e.g., Ward et al. 1995).

(d) A typical test matrix is shown in [Table 3-5](#). As the subsurface will be aerated in all cases, an anaerobic control may not be necessary in assessing biosparging.

(e) If the soil water pH is not in the range of 6–8 standard units, it may be adjusted to this range as another test condition.

(f) These tests are conducted on identically prepared flasks for each test condition, with sufficient flasks to test at 0, 3, 7, 14, 28 and sometimes additional days from study start. Usually duplicates are prepared so that additional statistical sampling may be conducted on some of the data. The flasks are sacrificed and tested for the contaminant concentrations in the soil and water phases at the specified intervals, and decay curves are calculated to derive an approximate degradation rate under laboratory conditions. The abiotic control indicates the amount of phase transfer that takes place in the absence of biodegradation, so the degradation rate can be appropriately adjusted.

**Table 3-5
Typical Degradation Test Matrix**

Test Conditions	Additives	Comments
Native conditions (air only)	None (slurry only)	Background
Nutrients at dosage 1	Ammonia-nitrogen, phosphate	Nutrient amended
Nutrients at dosage 2	Ammonia-nitrogen, phosphate	Nutrient amended
Abiotic control	Sodium azide, HgCl, or other microbial poison	Determine non-microbial effects
Duplicate of at least one condition above	Match above additives	Establish crude statistical basis
*At some sites, other matrices may be appropriate that do not include nutrient amended test conditions.		

(g) These tests are generally conducted at ambient indoor temperatures, not groundwater temperatures. In-situ biodegradation rates may be slower because the subsurface will generally

be colder than the laboratory test conditions, and groundwater will not be as well mixed as in the laboratory.

(h) These shake flask tests provide a basic indication as to whether the site conditions are favorable, or can be made favorable, for the indigenous organisms to degrade the organic materials at the site. For longer tests, they may indicate the maximum removal that might be achieved at the site using biosparging. Such data may be useful for establishing a lower limit cleanup level for contaminants of concern. However, the lower limit observed in the laboratory will probably be below the concentration that should be expected in-situ.

(i) Rather than (or in addition to) monitoring concentrations of contaminants, respiration tests may be used to monitor microbial activity. A respiration test may entail measuring the rate of oxygen disappearance (uptake) as degradation proceeds. A degradation rate can then be calculated based on the uptake rate. Another variation uses the generation rate of carbon dioxide to do a similar calculation. Both of these approaches must be evaluated with respect to abiotic sources and sinks for oxygen and carbon dioxide. In the oxygen uptake case, reduced iron may compete with bacteria for oxygen. For carbon dioxide generation, inorganic carbonate may act as a source or sink of carbon dioxide. Monitoring both oxygen uptake and carbon dioxide generation can help to clarify these confounding influences. Extended respirometry tests require a source of oxygen into the test apparatus at a controlled rate to ensure an adequate supply in the closed system. However, batch tests may also be conducted using only a probe to monitor dissolved oxygen, in solution. Respirometry tests may be less expensive than other laboratory biodegradation tests.

3-4. Feasibility Studies.

a. Generally, the feasibility study is a combination of the physical, chemical and biological evaluations described in the previous chapters, and leads to a pilot test of some form if the technology still appears promising. At some sites, certain components of a feasibility study can be dispensed with because they are not necessary. For example, if the biodegradability of the contaminants of concern has already been established, (e.g., sites with jet fuel contamination), the decision may be made to forego all or part of the bioremediation evaluation. Although laboratory column studies simulating IAS can be instructive in elucidating airflow mechanics (e.g., Ji et al. 1993), they are generally not justified as part of a feasibility study because they are not likely to represent the larger scale of the site.

b. A part of the feasibility study is an economic evaluation of the likely cost to test and implement IAS, in comparison to other technologies. Most feasibility studies recommend the technology that is likely to attain the cleanup goals for the site at minimum cost. For an in-situ technology such as IAS, this cost of treatment is very site specific, and is primarily affected by the concentration and mass of hydrocarbon to be treated, the depth of the plume and its relationship to the water table depth, the areal extent of the plume to be treated, and the ZOI that can be generated and maintained in the formation.

- c. Another approach that may especially be applicable to small sites can include a limited pilot study in the initial phases of a project. Such a test may cost effectively demonstrate the feasibility or infeasibility of IAS, and may be considered a prequalification test ([paragraph 4-3c](#)).
- d. Pilot Test methods and guidance will be provided in [Chapter 4](#).

CHAPTER 4

Pilot Tests

4-1. Introduction. Pilot tests have their greatest potential value in proving that technologies can be demonstrated to work properly at a specific site. Even if IAS processes were perfectly understood (which is not the case), pilot tests would still be needed because the site conditions are not perfectly known. Pilot tests are essential to ensure that the design variables that must be determined empirically are properly measured. They also permit the designer to try variations on the basic design to optimize the application to a particular site geology.

4-2. Pilot Testing Strategy.

a. The primary objective of a pilot-scale IAS test is to evaluate the subsurface response to air injection and extraction. Sufficient time may not be available to evaluate contaminant fate and removal rates. The primary objectives of the pilot test include the following.

- (1) Determine if injected air can reach the vadose zone in the vicinity of the IAS well.
- (2) Determine the pressure and flow characteristics at the location of the IAS well.
- (3) Determine the duration of groundwater transients during start-up and shut-down.

b. During continuous IAS pilot tests, data can be collected about the approximate extent of the ZOI, optimal injection rates and pressures, and off-gas handling considerations. The duration of the expansion and contraction transient phases is also of interest for pulsed IAS systems. The selected strategy will determine the preferred monitoring techniques and IAS mode of operation.

c. The results of pilot-scale testing may represent the physical conditions (e.g., IAS air-entry pressure, pressure distribution, air-filled porosity) that will occur during full-scale operation, but they may not predict the long-term chemical behavior (e.g., contaminant concentrations, dissolved oxygen [DO] levels) during full-scale IAS. Different pilot-scale testing approaches often yield different predictions of full-scale remedial success.

d. Variables that are particularly important to consider when designing an IAS pilot test include the soil stratigraphy, local or temporary hydrogeological conditions (e.g., water level, the presence of subsurface structures), and the presence of NAPL.

(1) Stratigraphy may be the single most important factor to understanding whether IAS can potentially be successful at a site. Therefore, particular attention must be paid to the relationship among the location of the sparge well screen, the target soil and groundwater contamination, and the nature of the soil strata at and above the well screen. If air cannot flow through the strata that are contaminated, then IAS will not be successful.

(2) The depth of the water table relative to the depth of the contamination, and relative to “normal” water table depths, will significantly affect both the perceived success of the pilot test and the applicability of the pilot test data to future system operation. The ZOI predicted by a pilot test may be quite different from the ZOI observed during future system operations if the water table elevation changes at a later date. Lower water tables (relative to the pilot test level) reduce the amount of time that air spends in the saturated subsurface and thereby can result in less lateral air flow or less contaminant removal.

(3) Subsurface structures can reduce a ZOI or produce an asymmetric ZOI by inducing local short-circuiting.

(4) Assessing the presence of NAPL should include more than monitoring wells for free product. As even residual NAPL (i.e., below the water table) can limit the effectiveness of IAS, it is important to carefully assess whether NAPL is present by a variety of means, such as visual inspection, laser induced-fluorescence, or dye testing of intact soil cores. If NAPL is detected it should be removed to the extent practicable prior to doing IAS pilot testing (NFESC 2001).

e. Pilot-scale tests typically are focused on determining the ZOI ([paragraph 2-8a](#)). If sufficient time is available, the ZOI may be determined by measuring changes in groundwater DO and contaminant concentrations. If testing must be done in a relatively short time, geophysical measurements of saturation (neutron probe, time-domain reflectometry, or resistivity tomography) can be very useful. It should be noted that establishing the ZOI based on DO data requires a significant number of monitoring points, which are not readily available at most sites. It will require additional time to install wells prior to system operation.

f. Tracer gases, including sulfur hexafluoride and helium, can be injected and traced to rapidly estimate the ZOI, subsurface travel times, and the efficiency of capture of volatile emissions (USEPA 1996). Groundwater analytical results obtained from samples collected while sparging is active or the aquifer has not stabilized may not represent stabilized conditions. In-well aeration of monitoring wells ([paragraph 3-3d\(2\)](#)) is a particular concern during pilot testing and operation of full-scale IAS systems; therefore, groundwater concentrations are best measured in monitoring points having short screen intervals (e.g., less than 60 cm) that do not promote in-well aeration. In cases of standard monitoring wells having long screen intervals that may preferentially conduct air, measurements are best made either prior to IAS startup, or a while (at least several weeks) after IAS shutdown. Another option during IAS pilot testing is to actively extract groundwater while sampling so that analytical results are more representative of the aquifer. If an inappropriate pump is used, however, this approach may inadvertently alter the groundwater DO and VOC concentrations. To minimize the influence of pumping during sampling on groundwater flow patterns, low-flow sampling protocols should be utilized (Puls and Barcelona 1996).

g. At sites that may require a large IAS implementation (i.e., more than 5 to 10 sparge wells), it may be desirable to implement the system in phases, rather than all at once. A pilot test can be considered the initial phase of the IAS remediation. Pilot tests generally provide opera-

tional data for one or two wells in one or two relatively small areas of the site. However, given the large degree of heterogeneity and imperfect understanding of the extent of contamination at many sites, it may be premature to design and implement a large, multi-well IAS or IAS/SVE system based on a limited pilot test. Often the very execution of a remediation design (e.g., installation of remediation wells) dramatically increases our site understanding and confidence in the conceptual model. A prudent approach, if the pilot test results are encouraging, would be to continue operating the pilot test wells, and incrementally add additional injection and extraction wells. If the resulting system is installed in phases, then full-scale operational data can be developed and then used for modifying the design of subsequent system components.

4-3. Pilot Testing Guidance. Detailed guidance on conducting pilot IAS tests is provided in Marley and Bruell (1995) and Wisconsin DNR (1993), to which the reader is referred for specific component details. Following is a discussion of pilot test operating philosophy, and current trends in IAS evaluation methods. [Figure 4-1](#) presents a flow diagram for conducting a pilot-scale IAS test. The first step is selecting the test strategy, as indicated in paragraph 4-2. Second, select and install the injection and monitoring components. Note that there is often contamination in both the vadose and saturated zones at IAS sites. If the pilot test includes an SVE system, consult EM 1110-1-4001 for detailed guidance. Finally, injection tests are conducted at selected flow rates, with preliminary, transient, and steady state monitoring for each iteration. If sparging is to be conducted in a well field or with pulsed injection, tests should be conducted under varying pulsing intervals. [Figure 4-1](#) incorporates provisions for conducting both short-term pre-qualification tests, as well as longer term pilot tests used to develop a design basis for the full-scale IAS system. For example, depending upon budgetary and scheduling constraints, IAS monitoring alternatives may include only injection pressure/air flow rate, water level, and DO measurements from existing monitoring wells. In the event the results are favorable, a subsequent, longer-term test could be done to refine the IAS design parameters. [Table 6-1](#) should also be consulted, as it provides an overview of the equipment and steps involved in setting up and starting up an IAS system.

a. Equipment Guidance.

(1) Mechanical System. The air injection system consists primarily of an injection well, injection blower or pump, and ancillary equipment to include a pressure relief valve, inlet filter, and flow control valve to meter injection rates. Provisions should be made for measuring pressure, temperature, and flow at the wellhead. [Figure 4-2](#) illustrates a typical installation. Details on selecting and installing the mechanical system are provided in [Chapter 5](#). Blowers should be capable of injecting a minimum airflow of $0.08 \text{ m}^3/\text{min}$ (3 standard cubic feet/minute [scfm]) at the selected depth and pressure. Evidence exists (Wisconsin DNR 1993) that the optimal flow rate is as high as the formation can withstand without fracturing the aquifer. An additional danger of overpressurization is that it can induce annular seal leakage in the injection well. Maximum flow rates are limited by the overburden pressure, which includes the soil weight and water column weight. [Paragraph 5-3d](#) presents a method of calculating overburden pressure for a given sparge depth. The ultimate fate of pilot test components should be considered during the selection process, including whether the components may be incorporated into a full-scale IAS

system. Temporary aboveground plumbing and electrical connections are acceptable for pilot tests; however, care should be taken to ensure that the blower power supplies are adequate to prevent thermal overload, and that the air supply piping is compatible with the blower outlet temperatures; furthermore, provisions may be included for heat dissipation (e.g., air-to-air heat exchanger) between blower and sparge well. The surface mechanical system should be tested prior to injecting subsurface air to verify that the components work as designed.

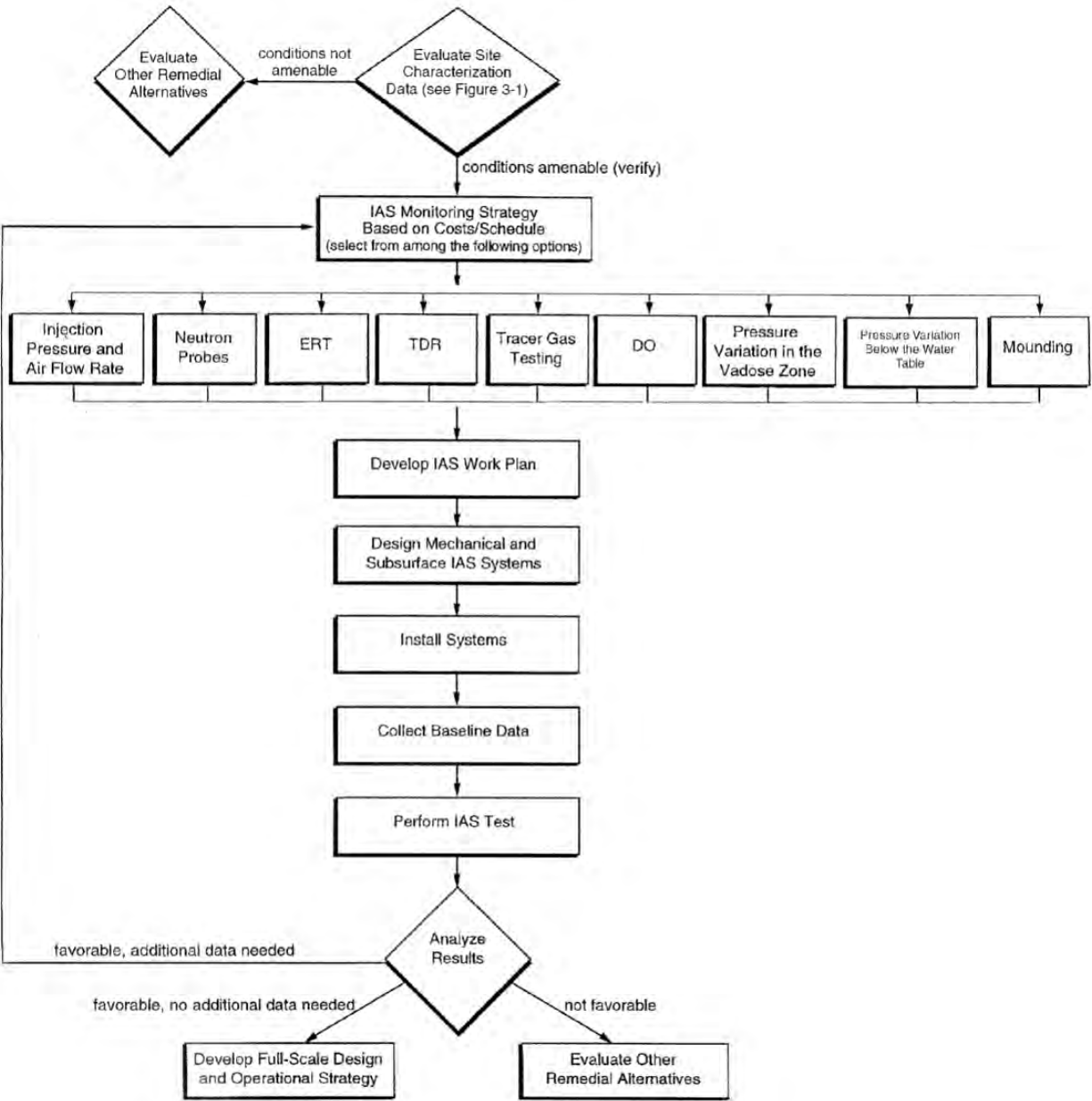

Figure 4-1. Pilot testing process.

(2) Injection Wells.

(a) With respect to pilot tests, the primary considerations for injection well construction are the depth to the top of the screened interval and preventing annular space short-circuiting. Practitioners have installed a variety of screen lengths and depths to the top of the screen. Screen length appears not to be a primary design consideration, as research indicates that air generally escapes within a very short interval near the top of the screen. Screen type also does not appear to be a significant design consideration, as pore size distribution in the formation controls air-flow. A 0.6-m (2-ft) length of continuous wrap well screen is generally acceptable ([paragraph 5-3c\(1\)](#)). Typical top-of-screen depths for pilot tests associated with shallow LNAPL contamination are 1.5 to 6.0 m (5 to 20 ft) below the water table. (Additional guidance on screen depth relative to stratigraphy, water table fluctuation, and contaminant distribution is provided in [paragraph 5-3c\(2\)](#)). Injection wells can be installed using hollow-stem auger drilling and standard environmental completion techniques or using steel pipe and direct push installation, though direct-push wells are not recommended because of the risk of air leakage around the pushed point ([paragraph 5-4a\(6\)](#)). Injection pipes can be connected to the riser using threaded connections, fittings, or no-hub connectors, but care should be taken to prevent air leakage at joints. It frequently is advantageous to finish the well-head with a tee, with air injection from the side and a threaded plug on the top to allow ready access to the well for sampling or gauging. A check valve may be necessary for pulsed injection to prevent backflow up the well following shutdown. Guidelines regarding well design and construction are discussed in more detail in [paragraphs 5-3 and 5-4](#).

(b) There are few available guidelines regarding the location of monitoring probes associated with a given injection well. However, injection well spacings ranging from 3.7 to 15 m (12 to 50 ft) have been reported in the literature (Wisconsin DNR 1993). Therefore, given a ZOI of 1.8 to 7.6 m (6 to 25 ft), monitoring probes should be located at distances less than 1.8 to 7.6 m to provide useful design data. Positioning monitoring points in various directions and at various distances from IAS points, as well as at various depths of interest, will enhance the data quality obtainable from the pilot test. As a minimum, there should be at least three monitoring points in the saturated zone, spaced from 1.5 m from the injection well, out to a distance equal to two times the depth of the sparge point screen below the water table

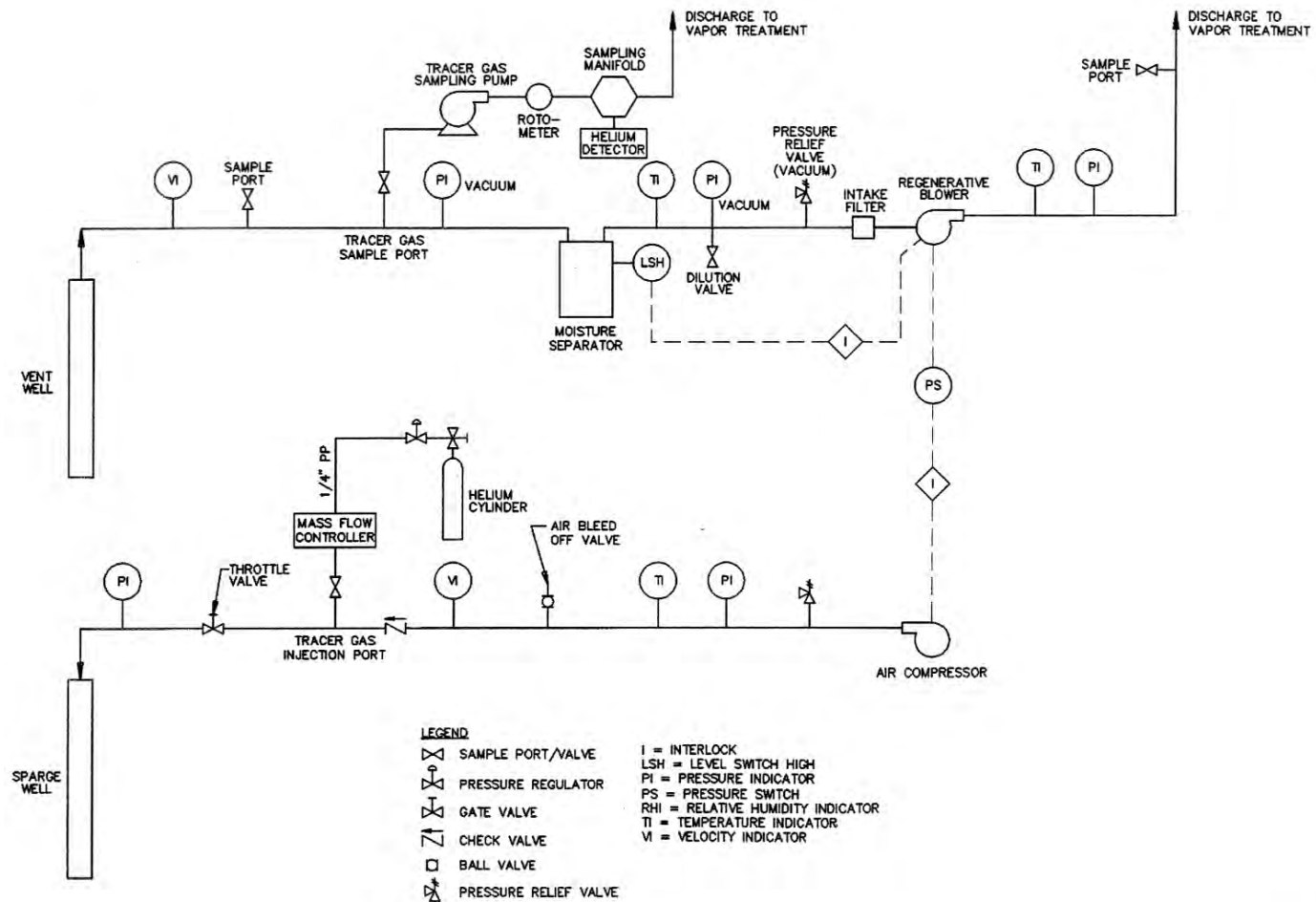

Figure 4-2. Pilot-scale piping and instrumentation diagram.

b. Pilot Test Monitoring Methods. [Table 4-1](#) summarizes data acquisition methods for pilot tests, not all of which will apply to a given test.

(1) Injection Pressure and Airflow.

(a) Injection pressure and airflow should be monitored at the IAS wellhead using an appropriately precise pressure gauge and flow monitoring device (e.g., anemometer, annubar, pitot tube). Be sure to develop the IAS wells first so that an accurate indication of the air-entry pressure of the formation can be obtained during this procedure. If the injection pressure, P_i , is increased gradually in small increments, and the corresponding injected airflow, Q , is precisely monitored, one of three general scenarios is likely ([Figure 4-3](#)) (Baker et al. 1996, Baker and McKay 1997). In each of the first two scenarios, Q will initially remain at zero until at least the hydrostatic pressure, P_h , is overcome ([paragraph 2-5](#)) (unless there is leakage in the delivery system between the point of measurement and the sparge screen).

- If airflow commences at, or very close to, P_h ([Figure 4-3a](#)), this is an indication that the observed air-entry pressure, P_e , is very small, and that airflow is occurring predominantly within the largest pores. Airflow may potentially be well-distributed in this case if the soils consist of uniform sands, but if the soils are non-uniform, preferential flow via the most permeable pathways is likely.

- If airflow does not become significant until a pressure well above P_h ([Figure 4-3b](#)), the sparge screen probably did not intersect macropores or high permeability lenses. Airflow may be well-distributed in this case if the formation consists of uniform fine sands or silts.

- Finally, if no significant airflow is measured, even when 0.6 to 0.8 times the overburden pressure ([paragraph 5-3d](#)) is applied ([Figure 4-3c](#)), then the sparge well should be depressurized. The sparge screen is probably installed in a low permeability, high air-entry pressure formation, and there is a risk of pneumatically fracturing the formation. If possible, it is recommended that sparging be relocated above such a layer, in a more permeable unconfined aquifer, if one is present.

(b) The interpretations of air-entry pressure as summarized above and in [Figure 4-3](#) are based on the special case in which hydrostatic pressure, P_h , is defined (see [paragraph 2-6a](#)) as being the elevation difference between the pre-IAS water table and the top of the IAS well screen. More generality is gained if P_h is viewed as being a function of the elevation at which air enters the formation. For example, consider the case in which the entire 1 m-long filter pack is in contact with a fine sandy soil having a moderate air-entry pressure, except for two identical coarse sand lenses, one at the top of the well screen, and a second 50 cm below the first, each having a relatively low air-entry pressure. Air will enter the upper coarse sand lens first, when the injection pressure, P_i attains the $(P_h + P_e)$ value of that lens. For air to enter the lower sand lens, however, P_i would need to attain the $(P_h + P_e)$ value of that lens, a pressure head 50 cm greater than the P_i required for air entry into the upper lens. Even though the two sand lenses are identical and both in contact with the filter pack, a greater pressure is required to overcome the greater hydrostatic head existing at the deeper layer (i.e., greater depth below the pre-IAS water

table). Baker and McKay (1997) provide examples of how this more general analysis has been applied.

Table 4-1
Pilot Test Monitoring Methods

Method	Applicable installations	Analytical equipment	Results
Injection Pressure and Airflow	Ports in wellhead or manifold	Pressure gauge, anemometer or pitot tube, datalogger	Apparent IAS air-entry pressure, well capacity, system requirements
Neutron Thermalization	Access tube consisting of bottom-capped 5 cm (2 in.) Sch. 40 carbon steel pipe	Neutron probe with source, and counter/detector	Vertical profile of saturation, ZOI
Electrical Resistance Tomography (ERT)	Electrode array attached to parallel PVC pipes, 1.5–7.5 m (5 to 25 ft) apart	Power supply, Current/volt meters, Analyzer	Saturation within plane of electrodes, ZOI
Time-Domain Reflectometry (TDR)	Steel waveguide pushed into bottom of soil boring	Electrical pulse generator/detector	Saturation in proximity of waveguide
Tracer Gas	Monitoring wells, Soil gas monitoring points, SVE wellhead	Tracer gas detector	ZOI, Air flow velocities, Percent capture
DO	Galvanic "Implants," Monitoring wells	DO meter, Flow cell, Data logger, in situ ampoules	Dissolved gas ZOI
Pressure (unsaturated zone)	Monitoring wells, Soil gas monitoring points	Differential pressure gauge	Air flow ZOI within unsaturated zone
Pressure (below water table)	Monitoring wells, Soil gas monitoring points	Differential pressure gauge	Steady state air flow ZOI
Hydrocarbon Offgas Concentrations	SVE wellhead, Soil gas monitoring points	FID, PID; vapor sampling equipment	Evidence that IAS is or is not causing significant increases in volatilization
Groundwater Elevation	Monitoring wells	Pressure transducer/datalogger	Groundwater mounding; optimal pulse interval

(c) Note that in the event that the filter pack extends a considerable distance above the well screen, the P_h value for this analysis must remain that of the top of the well screen, because water must be displaced at least to the top of the well screen for air to enter the filter pack. One cannot discern what layers have been invaded during IAS from monitoring of injection pressures alone. Stratigraphic information is also required, as is knowledge of the capillary pressure–saturation curves (and corresponding P_{infl} values) of, at a minimum, the least and most resistive layers between the IAS filter pack and the water table (paragraph 3-3a(2)).

(d) Stepped-rate testing of airflow and pressure can also be conducted in combination with other monitoring techniques, such as pressure measurement below the water table, neutron probes, or ERT, to determine the pressure and flow that produces optimal air saturation (McCray and Falta 1996, Morton et al. 1996, Acomb et al. 1995, Schima et al. 1996, Baker and McKay 1997).

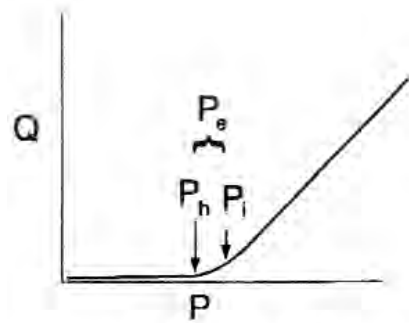

a. Low observed value of air-entry pressure indicates that flow is predominantly occurring within macropores

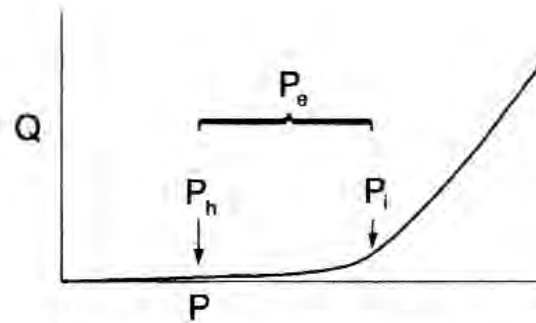

b. Substantial value of air-entry pressure indicates that flow is predominantly occurring within matrix porosity—an indication of well-distributed airflow.

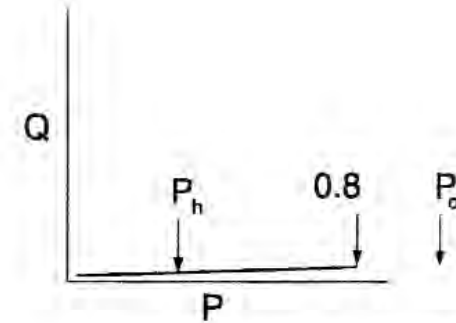

c. Lack of air-entry up until 80% of overburden pressure indicates that sparge screen is installed in a low permeability formation. Caution: there is a risk of pneumatic fracturing!

P_h = Hydrostatic Pressure
 P_e = Air-Entry Pressure
 P_i = Injection Pressure
 P_o = Overburden Pressure

Figure 4-3. Interpretations of air-entry pressure from flow vs. pressure data.

(e) It is recommended that the pilot test include more than one on-and off-cycle. Although the ZOI was not observed to change from one injection cycle to the next, the expansion phase is seen to reoccur during each pulse, during which the ZOI is somewhat larger than during continuous operation (McKay and Acomb 1996). Incorporation of pulsed IAS into the pilot test confirms the repeatability of the data, as well as facilitating selection of the pulse interval for design (paragraph 6-6b).

(2) Neutron Probes. One of the best available ways to determine actual airflow pathways during IAS is the use of neutron probes. Neutron probes measure the thermalization of emitted neutrons, which, being proportional primarily to the density of hydrogen, yields a precise measure of liquid saturation. Subsurface hydrogen is primarily contained in water, although hydrogen in contaminants is counted as well. The typical probe emits fast neutrons from an Americium-Beryllium source and counts slowed neutrons using a thermal neutron detector (Gardner 1986). The probe is suspended from a cable and sequential measurements are taken throughout the length of an access tube. The spherical zone of measurement extends 15 cm in radius from the probe in saturated soils, and as much as 40 cm in unsaturated soils. Neutron probe operation conducted during IAS pilot tests should conform to ASTM standard D5220-92; however, in lieu of full calibration (which is not needed because precision rather than accuracy is required), counts of thermalized neutrons during IAS can simply be compared with baseline (0% air saturation) counts collected prior to IAS. Figure 4-4 depicts a typical pilot test layout showing four neutron probe access tubes arrayed along a radial extending outward from the IAS injection well, and Figure 4-5 presents results from one such test conducted in uniform sands (Acomb et al. 1995, McKay and Acomb 1996). Figure 4-6, by contrast, shows results from a test conducted in a stratified formation, in which only slight changes of saturation are evident during IAS (Baker et al. 1996). Such results were also obtained during an IAS pilot test at the U.S. Army Engineer Research and Development Center's Cold Regions Research and Engineering Laboratory (CRREL), Hanover, NH (Baker and McKay 1997).

(3) Time-Domain Reflectometry. Time Domain Reflectometry (TDR) measures soil moisture content by propagation of electromagnetic pulses along a pair of transmission waveguides in direct contact with the soil. TDR offers a precise measurement of soil moisture content because the dielectric constant of dry soil particles (approximately 3 to 5) differs so much from that of water (approximately 80) (Topp et al. 1994). TDR systems have been deployed for IAS monitoring (Clayton et al. 1995) by pushing a pair of waveguides (a probe) into the bottom of a soil boring to a known depth, and backfilling the portion of the soil boring above the waveguide with grout. Each pair of buried waveguides typically consists of twin parallel steel rods approx. 0.7 cm in diameter and 6 cm apart, with the length of the waveguide selected on the basis of the depth over which one is interested in measuring an average moisture content. An electromagnetic pulse is generated that travels down the two parallel waveguides and the velocity of propagation of the reflected wave is calculated. The zone of measurement extends only approximately 1–2 cm from the waveguide. TDR is a well-established technology, provides real time moisture and time-series measurements, and can be procured commercially, although probes suitable for deep installations usually must be custom-fabricated.

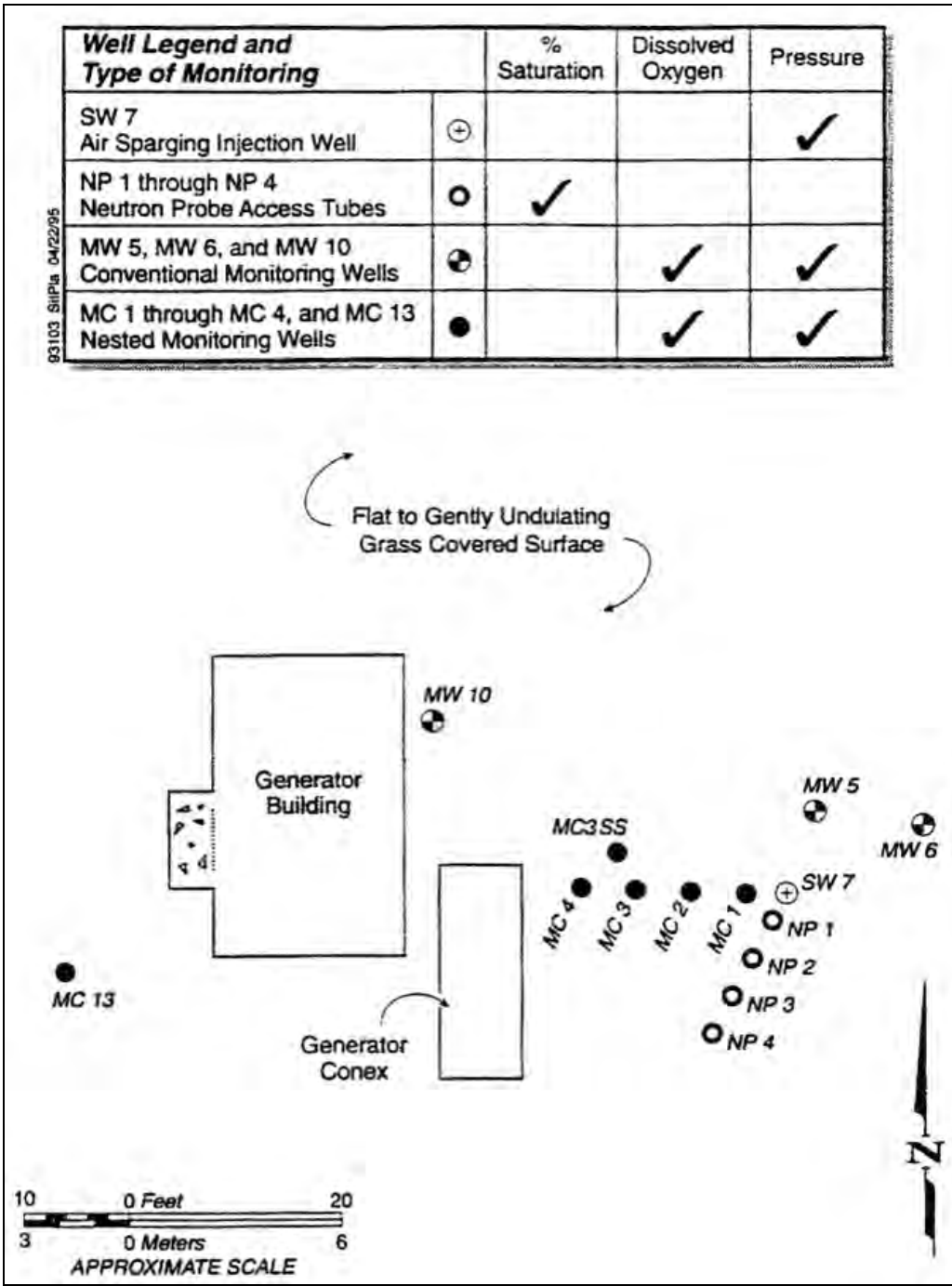

Figure 4-4. Site plan showing air sparging injection well, neutron probe access tubes, and monitoring wells used in the study. Water levels were also measured at the monitoring wells (after Acomb et al. 1995).

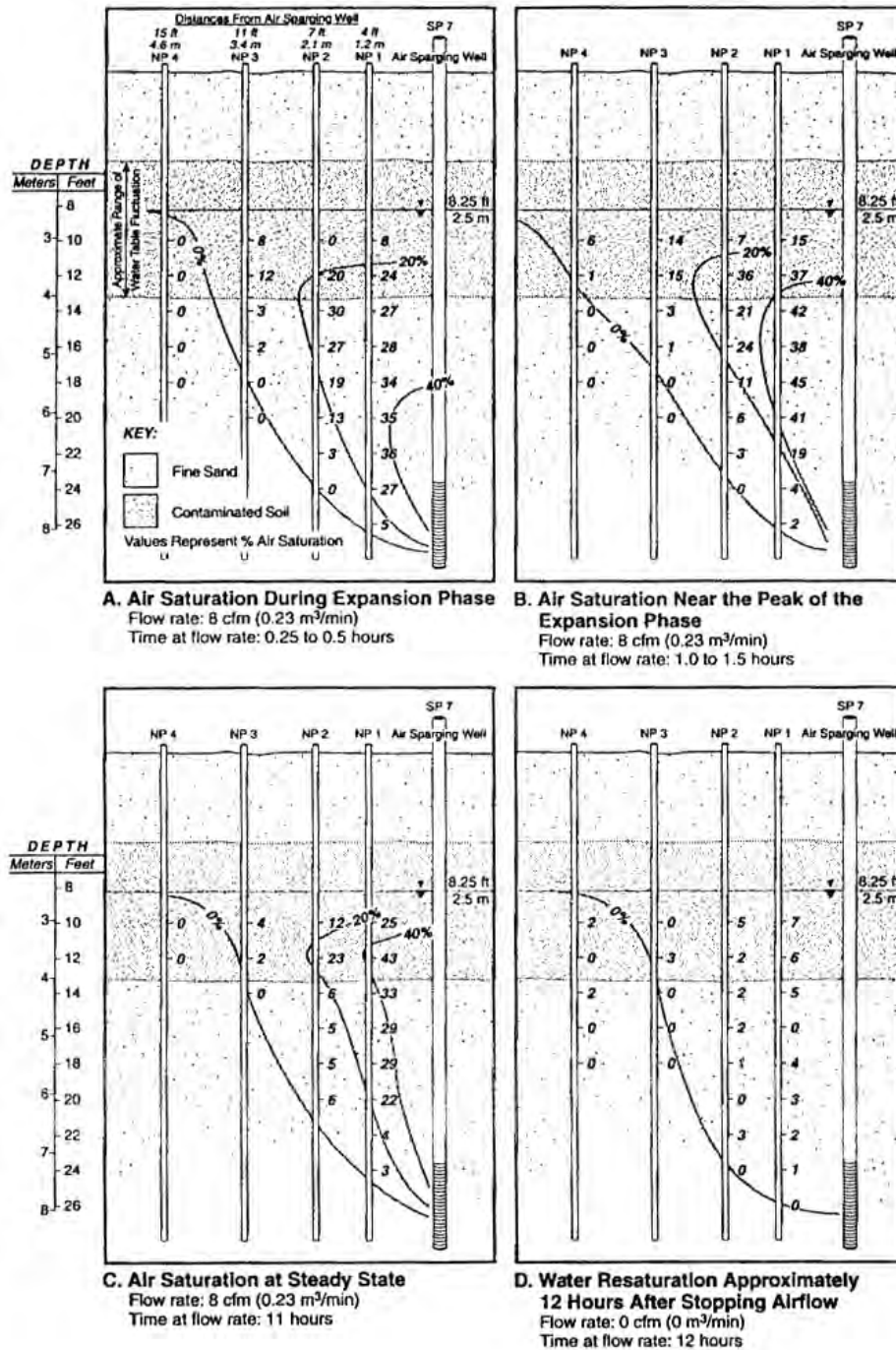

Figure 4-5. Cross section through the air sparging well and neutron probe pipes showing changes in air saturation through time (after Acomb et al. 1995).

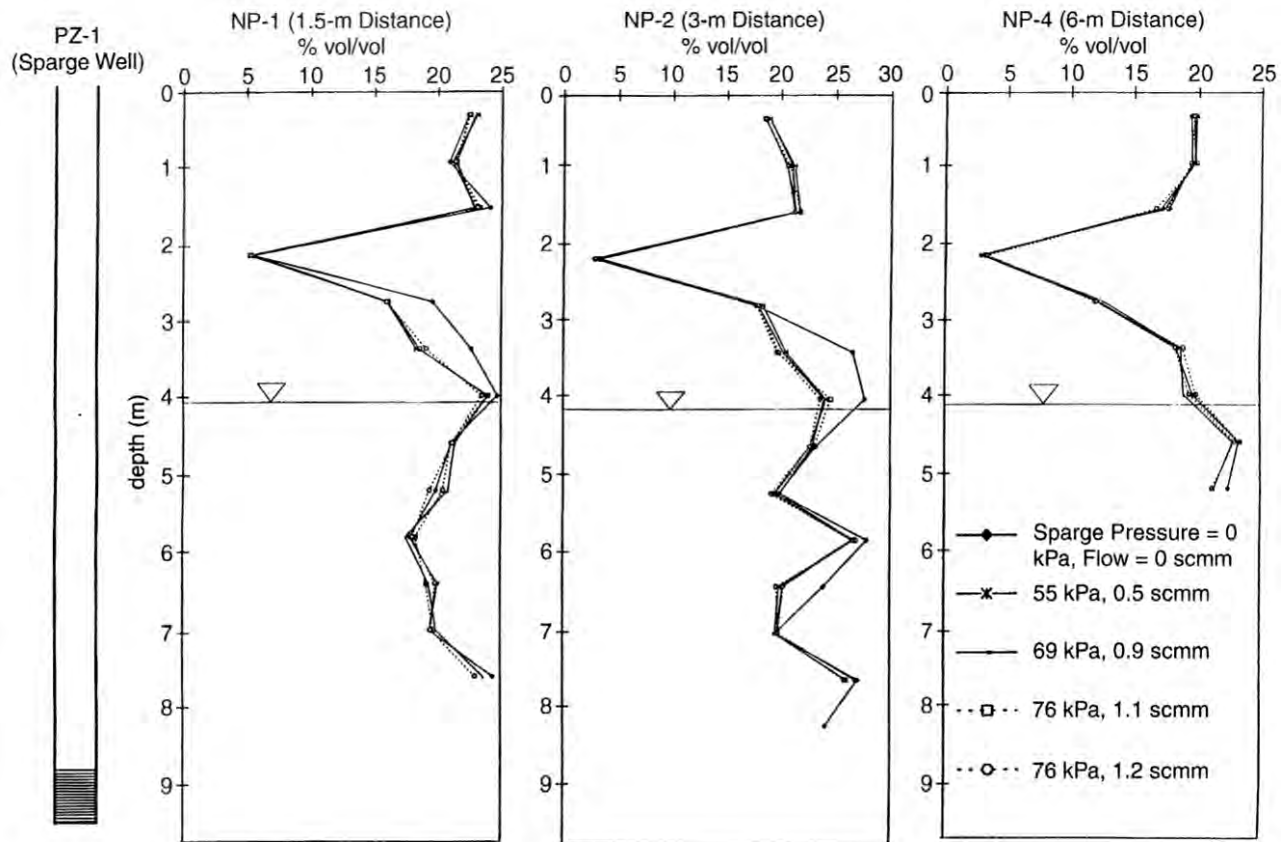

Figure 4-6. Moisture profiles obtained by neutron logging at 1.5, 3, and 6 m from the IAS well during various stages of the IAS test, showing the pre-test water table elevation for reference. Differences between the baseline measurement (spurge pressure = 0, flow = 0) and all subsequent measurements indicated the minimal air saturation due to IAS at this highly stratified site (after Baker et al. 1996).

(4) Electrical Resistivity Tomography. Electrical Resistivity Tomography (ERT) is a technique that can be very effective in monitoring the distribution of air associated with IAS programs. The technology provides two-dimensional images of the resistivity distribution between two boreholes. The resistivity distribution is a function of water saturation, porosity, clay content, and electrical conductivity of the pore fluid. As a result, areas within the subsurface characterized by a low water saturation (i.e., that created by air injection during IAS), will have a relatively high resistivity in the resistivity distribution image (Schima et al. 1996). Consequently, ERT may be used to determine the air saturation adjacent to an IAS well. An example electrode layout is shown in Figure 4-7, while results from a sandy site are presented in Figure 4-8. Investigators such as Schima et al. (1996) utilized well spacings of approximately 1.5 to 7.5 m to develop resistivity profiles. Their findings, as well as those in Lundegard and LaBrecque (1996) suggest that ERT provides a robust mechanism for monitoring spurge performance and the distribution of air within the saturated zone during IAS. This method has been employed in IAS

research, and shows considerable promise for IAS pilot scale test monitoring. Although the setup and instrumentation may be more costly than other monitoring methods, the data interpretation costs are not anticipated to be particularly high. Algorithms for analysis of tomographic data are common. Given the potentially high resolution of subsurface conditions in three dimensions, there may be air sparging applications that make the benefits of ERT worth the costs.

(5) Dissolved Oxygen. Dissolved oxygen concentrations within the saturated zone are used alone or in concert with dissolved tracer concentrations to estimate the extent of potential contaminant removal through biodegradation and an approximation of ZOI. DO distribution is controlled by advective and diffusive mechanisms. DO concentrations are measured within monitoring points by devices such as galvanic oxygen probes connected to dataloggers, or by collecting representative groundwater samples from monitoring wells for analysis by standard surface DO analytical techniques. It is imperative that groundwater collection locations be isolated from the atmosphere during air injection to preclude in-well aeration, and that measurements be made directly in the wells where possible to prevent biodegradation from reducing the DO in the sample to below the level in the well. It is also advisable to employ monitoring points screened entirely below the water table within zones of interest. The use of low-flow sampling devices for purging and sampling minimizes variations in groundwater flow patterns adjacent to conventional well screens and the potential for mobilizing suspended, fine grained material, which may bias groundwater chemistry data. Procedures for low-flow (minimal drawdown) groundwater sampling have been described by Puls and Barcelona (1996). Alternatively, comparisons of pre-IAS and post-IAS DO can conveniently be made in-situ by lowering prepared vacuum ampoules (e.g., ChemEts[®]) containing reagent into a sampling well and using a trigger mechanism to break the ampoule's tip, allowing groundwater to enter the ampoule and react with the reagent. The ampoule is then lifted to the surface and compared with colorimetric standards. This method is fast, inexpensive, accurate, and minimizes the aeration that can occur while pumping groundwater to the surface (Pannell and Levy 1993).

(6) Pressure within the Vadose Zone. Pressure within the vadose zone can be monitored using soil gas probes connected to differential pressure gauges. These values have been used to approximate the ZOI surrounding an IAS injection well. However, research has indicated that this method may overestimate the actual ZOI by up to an order of magnitude, depending on the definition of ZOI, because the pressure influence propagates beyond the air exit points (Figure 4-9) (Lundegard 1994). Changes in soil gas pressure in the vadose zone can indicate sparge air migration from the saturated to the unsaturated zones; however, they also can result from barometric pressure changes, and can be difficult to attribute to IAS airflow owing to the piston effect of rainfall events, as well as pressure changes caused by SVE systems, if concurrently operating. Although vadose zone pressure measurements are not a clear indication of where airflow is occurring, it may be possible to predict the ZOI at the water table by adopting certain flux assumptions and factoring in measured soil gas pressure gradients (Wilson et al. 1992). Measurements of pressure within the vadose zone at multiple points can also be used to demonstrate continuity, or lack thereof, within strata.

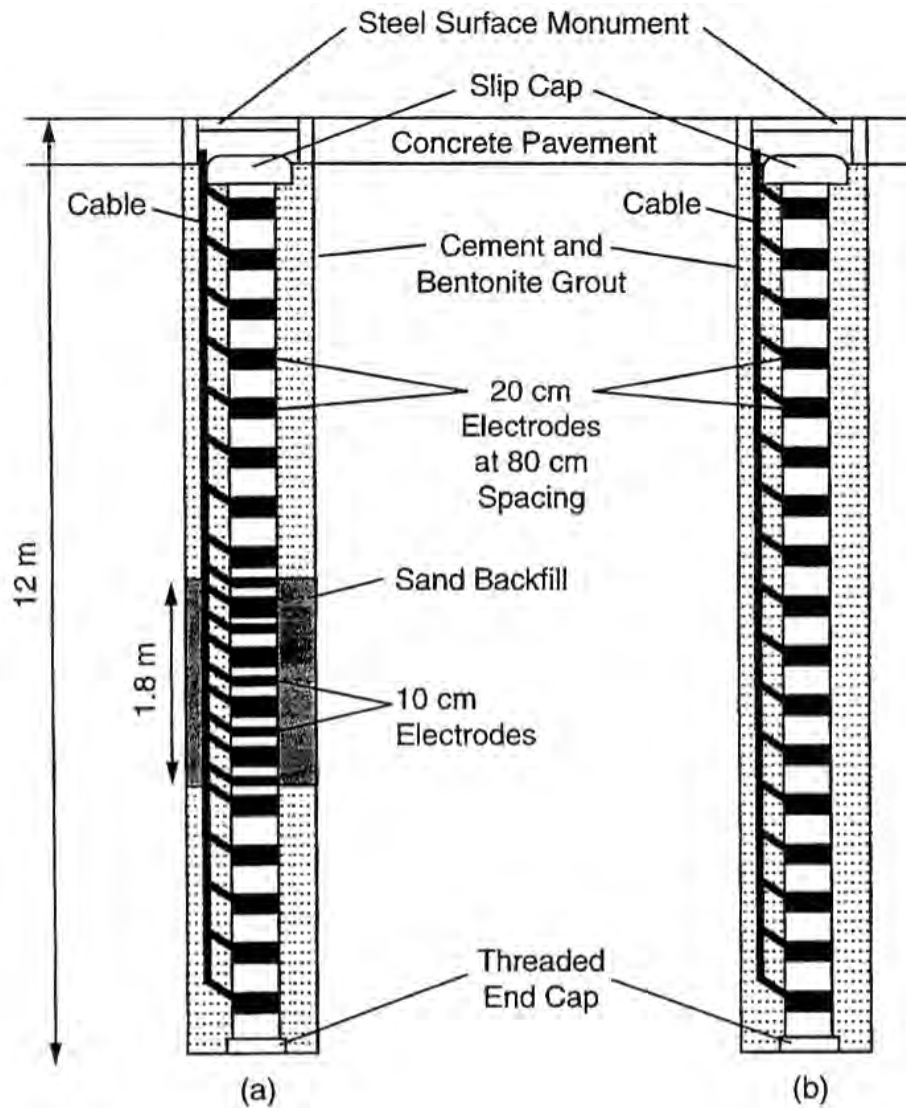
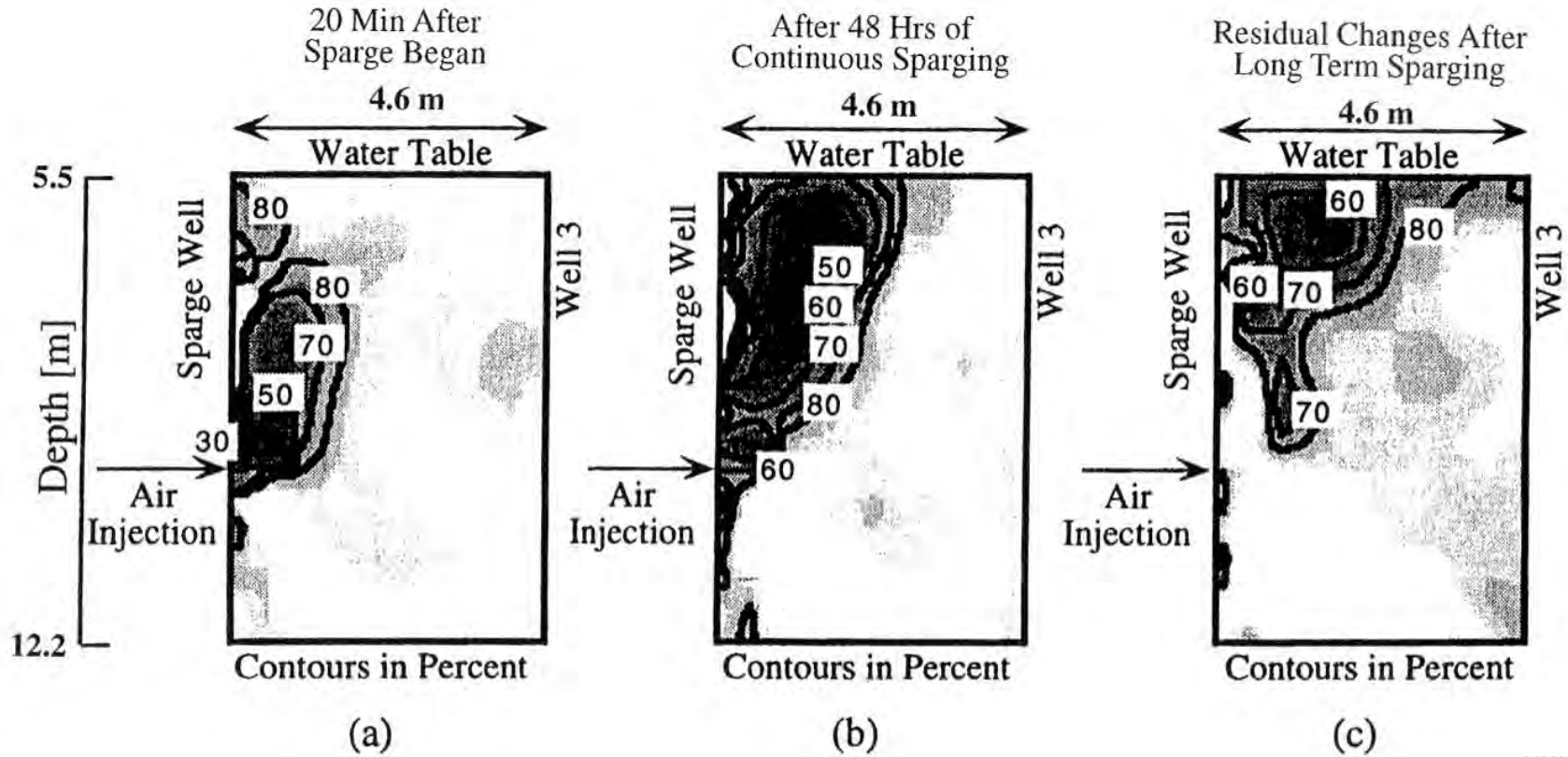

Figure 4-7. (a) ERT electrode layout in sparge well and monitoring well; (b) electrode layout in additional monitoring points. Neither are drawn to scale (from Schima et al. 1996; reprinted by permission of Ground Water Monitoring & Remediation, copyright 1996, All rights reserved).



M05073

Figure 4-8. ERT image showing percent water saturation in the saturated zone between the sparge well and a monitoring well. Contours are as labeled. (a) Twenty minutes of continuous sparging; (b) near steady-state conditions, after 48 hours of continuous sparging; and (c) residual changes after all sparge events have stopped (from Schima et al. 1996, reprinted by permission of Ground Water Monitoring & Remediation; copyright 1996; all rights reserved).

(7) Pressure Measurements in Probes Installed below the Water Table. Pressure changes during IAS can be measured at the wellheads of monitoring probes (soil vapor probes, piezometers or wells) screened entirely below the water table. The observed results will differ, depending on whether or not air channels intersect the probes. If sparged air does intersect such a monitoring point, it will readily enter the probe, which has a negligible entry pressure. A gauge or transducer connected to the capped top of the probe will then show a pressure increase equal to the pressure in the air channel that impinges upon it. If still evident upon achievement of steady state conditions (i.e., after decay of the transient groundwater mound), such a pressure increase can be viewed as equal to the capillary pressure head within the partially desaturated portion of the formation through which the sparged air is flowing (McCray and Falta 1996, Morton et al. 1996). That capillary pressure head, in turn, can be related directly to the air saturation using the soil's moisture retention curve (paragraph 3-3a(2)). Given a sufficient number of monitoring probes, the spatial distribution of air saturation and thus the air sparging ZOI can be accurately delineated (McCray and Falta 1996, Morton et al. 1996, Larson and Falta 1996).

(a) If air channels do not intersect the probes, pressure increases will still be evident, but only during the transient phases that follow IAS start-up or shut-down. Such readings indicate how a pressure pulse propagates away from a sparge point during the expansion and collapse phases of IAS, and are thus related to groundwater mounding (paragraph 4-3b(8)). Transient pressure increases following IAS start-up should not be construed as meaning that airflow is occurring at such monitoring points. Thus, the ZOI need to be interpreted with caution on the basis of transient pressure changes at monitoring points (Lundegard 1994, Acomb et al. 1995).

(b) It is important to note that air trapped in the saturated zone can sometimes take a prolonged period of time to dissipate following air injection. Lundegard and LaBrecque (1996) observed that 19 hours after IAS ceased, air was exhaling from a piezometer screened below the water table at the rate of $0.014 \text{ m}^3/\text{min}$ (0.5 scfm) and with a shut-in gauge pressure of 20.7 kPa (3 psi), behavior consistent with the gradual deflation of trapped air that they imaged by ERT.

(8) Groundwater Elevation Changes. Groundwater elevation changes can be monitored via water elevation probes in water table monitoring wells, or via pressure transducers installed at selected depths and locations in such wells and connected to dataloggers. Although a pressure transducer is capable of measuring the hydrostatic pressure associated with a change in the water table surface (i.e., that related to mounding), the head, measured in centimeters of water, is calculated by assuming a specific gravity of 1.0. In cases where the fluid column in the aquifer consists of a mixture of water and air (e.g., during effective IAS), a correction to the fluid density is needed to calculate the change in head (centimeters of water) attributable to mounding. Therefore, it may be more appropriate to report the mound buildup and decay as a pressure in kilopascals rather than in centimeters of water.

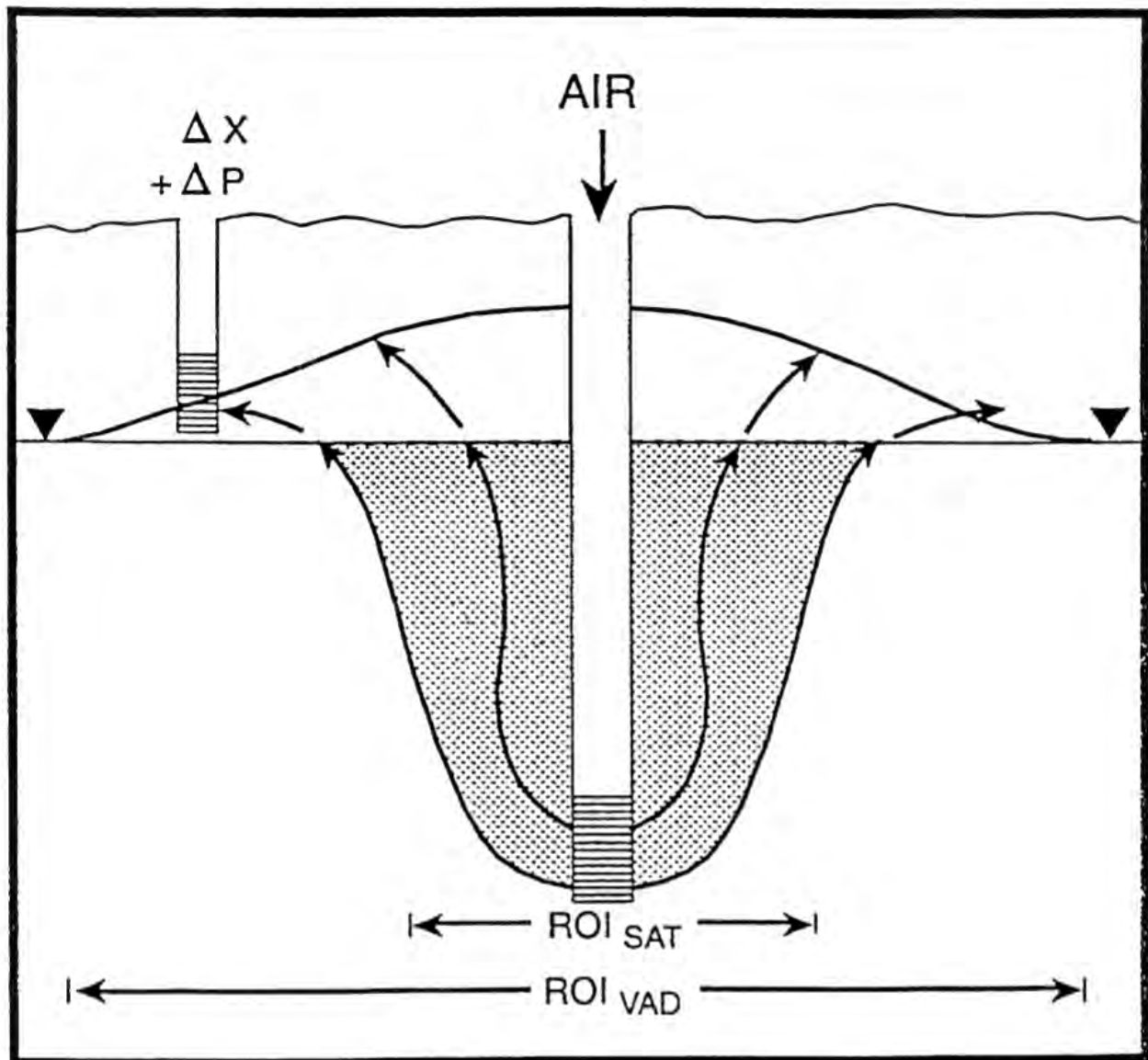

Figure 4-9. Schematic representation of the difference between the air sparging region of influence in the saturated zone (ROI_{SAT}) and in the vadose zone (ROI_{VAD}). The Region of influence will generally be less in the saturated zone than in the vadose zone. Discrete Measurements of vadose zone properties, such as pressure (ΔX), will lead to estimated ROI_{SAT} values that tend to be too large (from Lundegard 1994; reprinted by permission of National Ground Water Association; copyright 1994; all rights reserved).

(a) Groundwater elevation changes have also been used to approximate the ZOI around IAS injection wells, but research has shown that changes in hydrostatic head radiate outward from the center of the transient groundwater mound far beyond the locations of air channels (Figure 2-7) (Lundegard 1994, 1995). Therefore, such results are not indicative of regions subject either to groundwater mixing or to air-filled channels.

(b) The magnitude of mounding depends on site conditions and the location of the observation well relative to the sparge well. Groundwater mounds of as much as 0.5 to 1 m have been reported in the literature (Brown et al. 1993, Boersma et al. 1993, Lundegard 1995) although in coarse sands and gravels, the mounding may be almost nondetectable. Lundegard (1995) reports mound buildup at distances of 1.5 to 19 m (5 to 63 ft) in a relatively homogeneous sand aquifer under an injection pressure of 41 kPa (6 psig) and an air flow rate of 0.5 scmm (18 scfm). The mounds dissipated within 3 to 4 hours after continuous air injection. In contrast, mounding associated with a heterogeneous sand unit with interbedded gravel and silt was observed in monitoring wells located at distances of 33 m (108 ft) from the injection well. The mound dissipated to within 85% of the initial water surface elevation after approximately 5.3 hours of continuous injection. Maximum mounding was reported in a well located approximately 1.8 m (6 ft) from the injection well and was approximately 0.4 m (1.3 ft) in height (Lundegard 1995). The amount of time it takes for the groundwater mound to dissipate is the recommended basis for determining pulsing on-off cycles. The desired objective is for the groundwater to remain mounded during the entire time air is supplied to a given well (paragraph 6-6b).

(c) It should be noted that changes in the barometric pressure should be recorded from monitoring wells during the sparge test. These wells should be located beyond the ZOI to account for temporal variations in the water table surface during the test.

c. Monitoring Frequency.

(1) Monitoring should be started immediately before commencing injection (to establish baseline conditions), and as continuously as practicable for each parameter during the initial transient conditions. As discussed in paragraph 2-5f, in uniform fine sands, initial conditions have been observed to include an expansion of the air-saturated zone, followed by a collapse phase (Figures 2-6 and 4-5) (Acomb et al. 1995). The ultimate “steady state” conditions also are dynamic to varying degrees for different parameters, although at a different time scale than the initial transient mounding conditions. It is imperative that all the necessary background parameters discussed in Chapter 3 be measured and evaluated before injecting or extracting subsurface air, as perturbations can take extended periods of time to return to the original conditions, if ever. As an alternative to monitoring barometric pressure, water level fluctuations can be monitored in a background well prior to, during, and following IAS. Vertical and horizontal positions should be surveyed for all monitoring locations for modeling and evaluation.

(2) Most pilot tests have been conducted for relatively short times, often less than one day (Marley and Bruell 1995). It is recommended, however, that sufficient time (e.g., a minimum of 8 hours, and in some instances, weeks) be set aside to ensure attainment of Data Quality Objectives (EM 200-1-2). The most modest of pilot test objectives would be simply to prequalify a site as potentially suitable for IAS, by measuring injection pressure and airflow during the onset of IAS (paragraph 4-3b(1), Figure 4-3). Such a test can be conducted and repeated in a day (Baker and McKay 1997, McKay and Baker 1997). A more common approach would be to maintain the test to the point of re-equilibration of water levels (stable air paths) during IAS. If

the goal is only to determine ZOI during steady-state IAS (based on observed air saturation using pressure measurements below the water table, neutron probe testing, TDR or ERT), a short test of 8 hours to 2 days should be sufficient. If the goal is to observe oxygen uptake, then 2 to 4 days for the air injection portion of the test, followed by 2 to 4 weeks for the oxygen uptake portion of the test, may be advisable, especially if DO or tracer gases are being used as indicators of ZOI. Extending the pilot test by several days can be far less expensive than the cost of remobilization.

Finally, if the goal is to observe contaminant concentration decreases in groundwater, or indications of fouling, several months may be required, depending on site-specific conditions. Note that care must be exercised when relying on monitoring wells for VOC and DO measurements during and following IAS, as discussed in [paragraph 7-2](#).

d. Tracer Gas Tests.

(1) Tracer gas tests employ gases not naturally occurring in unconsolidated sediment, such as sulfur hexafluoride or helium, to indicate rates of subsurface gas flow. Ideally, the selected tracer gas closely approximates the physical and chemical characteristics of diatomic oxygen, such as solubility and density (molecular weight). During the IAS test, the tracer gas is injected at the well directly into the injection airstream. Equipment required ([Figure 4-10](#)) includes the gas source (gas cylinder), pressure regulator, flow meter, piping to the injection point, a sampling pump, a tracer gas detector, and cylinders of tracer gas at a range of known concentrations for calibration of the detector. Soil gas samples are typically collected from discrete soil gas sampling points in the unsaturated zone. These points must be sealed from the atmosphere when not being sampled to prevent short-circuiting. It may be necessary to purge sampling points after each sample collection. The soil gas sample results are interpreted to show the spatial distribution and velocity of the vapor flows, and to indicate preferential airflow pathways (Baker et al. 1995). It is also possible to inject a known mass of tracer gas and, by monitoring the tracer gas concentration in an overlying SVE system flow, determine the percentage of the injected gas that will be able to be captured (Johnson et al. 1996a). This technique should be employed whenever there are significant concerns about uncontrolled emissions to exposure points.

(2) Helium tracer testing involves injecting helium at a concentration of approximately 5% in air to limit the potential for differential density-driven flows. Helium is monitored in the deep vadose zone to identify the general area where sparge air is penetrating the water table and, by inference, the zone of influence of a sparge system. Major advantages of helium testing include the ease of implementation and the low cost of helium, the helium detector, and associated equipment. The contrasting disadvantage is that helium testing does not indicate the actual three-dimensional zone of influence in the saturated zone, merely a two-dimensional representation of the uppermost portion of this zone.

(3) Sulfur hexafluoride has a similar solubility to oxygen in groundwater and is used as a tracer for monitoring the saturated zone of influence of a sparge system. Unlike oxygen, sulfur hexafluoride is not affected by microbial activity and thus is a more conservative tracer than dissolved oxygen. Therefore, sulfur hexafluoride tracer testing is appropriate for pilot test sites

where conditions are such that oxygen introduced into the subsurface may be rapidly utilized, thereby rendering it less useful as an indicator of zone of influence.

(a) Sulfur hexafluoride can be metered into the sparge air at a low concentration. Groundwater samples are collected from monitoring well piezometers and are analyzed by gas chromatograph and electron capture detector. Because sulfur hexafluoride is a gas at ambient temperatures, great care must be taken to collect groundwater samples without loss of volatiles. It is also imperative that groundwater collection locations be isolated from the atmosphere during air injection to preclude in-well aeration. Monitoring points with short screen intervals located entirely below the water table within zones of interest are most appropriate for this.

(b) An advantage of sulfur hexafluoride tracer testing is that it can directly indicate the three-dimensional zone of influence around a sparge point. However, the extent to which this three-dimensional zone is defined is a function of monitoring point and sampling density, and therefore, rigorous testing can add to pilot test complexity and expense.

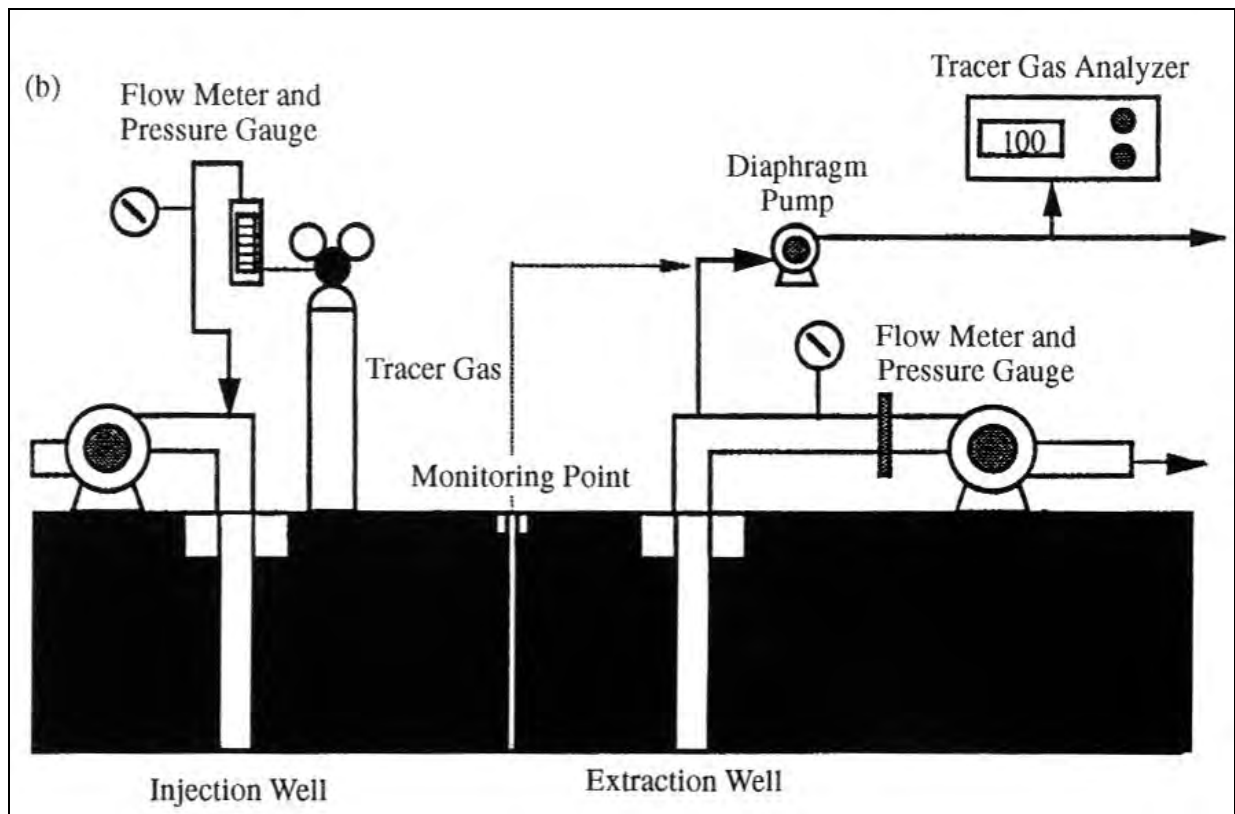

Figure 4-10. Tracer gas measurements and helium recovery test (after Johnson et al. 1995).

e. Respirometry Testing. Saturated zone in-situ respirometry methods have recently been tested at an IAS site at Fort Wainwright, Alaska (Gould and Sexton 1996). Microbial uptake of DO in the saturated zone was measured quarterly, and the decrease in DO concentration was at-

tributed to biodegradation of hydrocarbons based on certain assumptions, including soil porosity and ZOI. Accounting for advective and dispersive fluxes of DO away from the ZOI following IAS shutdown, as well as the effects of non-target inorganics such as ferrous iron on oxygen uptake, are limitations of such methods.

f. Potential for Vapor Intrusion into Buildings. In situations where the pilot test is conducted near occupied buildings, some monitoring of the potential for vapor migration toward occupied buildings may be appropriate. Monitoring of vapor concentrations in vapor probes set outside these buildings would be most effective at providing early warning of vapor migration. Vapor probes should be monitored first to screen for acute toxic hazards followed by monitoring to determine the presence of chronic toxic hazards. Monitoring for acute toxic VOC hazards can be performed by use of a PID or FID. Monitoring for chronic VOC hazards can be conducted by use of Method TO 15 or equivalent. Indoor air monitoring should generally be avoided due to complications from background chemicals typically found in the buildings as well as the likelihood of logistical difficulties in obtaining access for sampling during the operation. The likelihood of air migration into the building given the relatively short duration of the typical pilot test should be considered in making decisions regarding such monitoring, particularly if one goal is evaluating the likelihood of vapor intrusion during full-scale IAS application.

CHAPTER 5

Design Considerations for Air Sparging Systems

5-1. Introduction. Prior to developing a design strategy, it is important to understand the processes responsible for removing the hydrocarbons and how they may be optimized. As mentioned previously, there are two primary processes: i) volatilization and ii) biodegradation. The success of an air sparging system depends on the ability of hydrocarbons to transfer from the water phase into the air phase, and oxygen (or other gas) from the air phase into the water phase.

5-2. Design Strategy.

a. Introduction. Given the conceptual background presented in foregoing chapters, it is evident that by increasing the rate of VOC and oxygen transfer across the vapor–liquid interface, the rate of contaminant removal can be enhanced. The rate of mass transfer across the vapor–liquid interface will largely be a function of vapor–liquid surface area (as well as the Henry’s constant of the contaminant). Therefore, the strategy behind designing an IAS–biosparging system must be focused on maximizing the vapor–liquid contact and, consequently, the mass transfer rates across the vapor–liquid interface.

(1) The primary strategic issues that the design team must consider when designing an IAS–biosparging system include the following.

(a) Is it more feasible or desirable to strip contaminants from the groundwater or to promote in-situ biodegradation? Should other groundwater amendments be considered to promote in-situ biodegradation?

(b) Is sparging being conducted to effect groundwater geochemical changes (e.g., for immobilizing reduced metals)?

(c) Is collection of vapors by SVE required to avoid fugitive emissions or unwanted vapor migration or escape?

(d) What subsurface well configuration will be necessary to cost-effectively deliver air to the zone of interest (e.g., horizontal or vertical injection wells)?

(e) Will pulsed flow or continuous flow maximize mass transfer rates across the vapor/liquid interface?

(f) Will the IAS system be large enough to benefit from a phased installation? Will data collected from operation of a first phase of the IAS system assist in the correct placement of future IAS wells or optimizing the use of aboveground equipment including the sparge compressor and off-gas treatment equipment? Can the pilot system be utilized as the initial IAS system phase, and the future system design be tailored based on operational experience?

(2) The answers to these questions will drive the configuration of both the below-ground and above-ground components of the IAS system. The data and approach that should be used to answer these questions are described conceptually in [Chapters 2 and 3](#). These data are in turn used as the design basis for the IAS system.

b. Delivery of Air. To optimize the mass transfer rate, it is important to understand the mechanisms that control channel formation and propagation, which were presented in paragraphs 2-5 and 2-6. Air (or another gas) is injected into a sparge well under pressure. As the air pressure is increased, standing water within the well is displaced. For the air to enter the formation, the air pressure must be greater than the sum of the water pressure (i.e., hydrostatic pressure) and the air entry pressure (equations 2-1, 2-2, and 2-3).

(1) Once air has entered the formation, its movement is dictated by the pressure differential between the air and water, as long as the air remains directly connected by continuous channels to the sparge well. In the event the channel “snaps off,” the resulting air bubble may travel through the formation, driven by the density difference between the air and water phases (buoyancy), but only in very coarse-grained sediments (grain sizes less than 2 mm, see [paragraph 2-7b](#)). Otherwise, flow occurs in the form of finger-like channels that remain in place as long as the air pressure is maintained. Qualitative observations indicate that an increase in air pressure causes an increase in channel size and the formation of additional channels (Ahlfeld et al. 1994). This is an important consideration for design. Recall that Mohr’s (1995) conceptual model suggests that channel location and density (i.e., number of channels per unit cross section) have a profound effect on both hydrocarbon removal and oxygen transfer rates.

(2) The stratigraphy governs the air channel distribution. Channel densities tend to be lower for stratified sediments, owing primarily to the lateral dispersion of air confined by overlying low permeability zones. An extreme example is the formation of air pockets or “air ponding” that may extend in lateral directions indefinitely beneath a confining layer unless an exit point such as a well screen is encountered ([Figure 5-1](#)) (Johnson et al. 1993, Baker et al. 1995). Based on the discussion above, micro-scale (i.e., pore-scale) and macro-scale (i.e., stratigraphic) heterogeneities have a profound influence on air channel location and density. During the conceptual design, it is important to reconsider these issues. For example, air channels that are spaced at significant distances from one another are not expected to provide adequate mass transfer and removal. In other words, for air sparging to be successful, it must produce enough air saturation with a small enough channel size so that there is sufficient interfacial area for mass transfer to occur ([Figure 2-5](#)) (Mohr 1995). Given low air saturation in small radius channels, there is very little interfacial area, and mass transfer will be very low. With high air saturation and large radius channels, the interfacial area is also very small, and diffusion still must occur over long distances. Only under high air saturation and small channel radius are the interfacial area sufficient and the diffusion path lengths short enough for moderate mass transfer rates to occur. Nomographs provided by Mohr (1995) suggest that channel spacings of 0.1 to 1.0 cm may be necessary to achieve reasonable rates of mass transfer. An increase in the channel density (i.e., an even smaller spacing between adjacent channels), will further enhance remediation rates.

At some point, however, increased airflow will tend to produce diminishing returns with respect to increased air saturation and channel density. This optimum might be determined through neutron probe or ERT measurements, or pressure measurements below the water table at various stages during a stepped-flow test (paragraph 4-3b(1)).

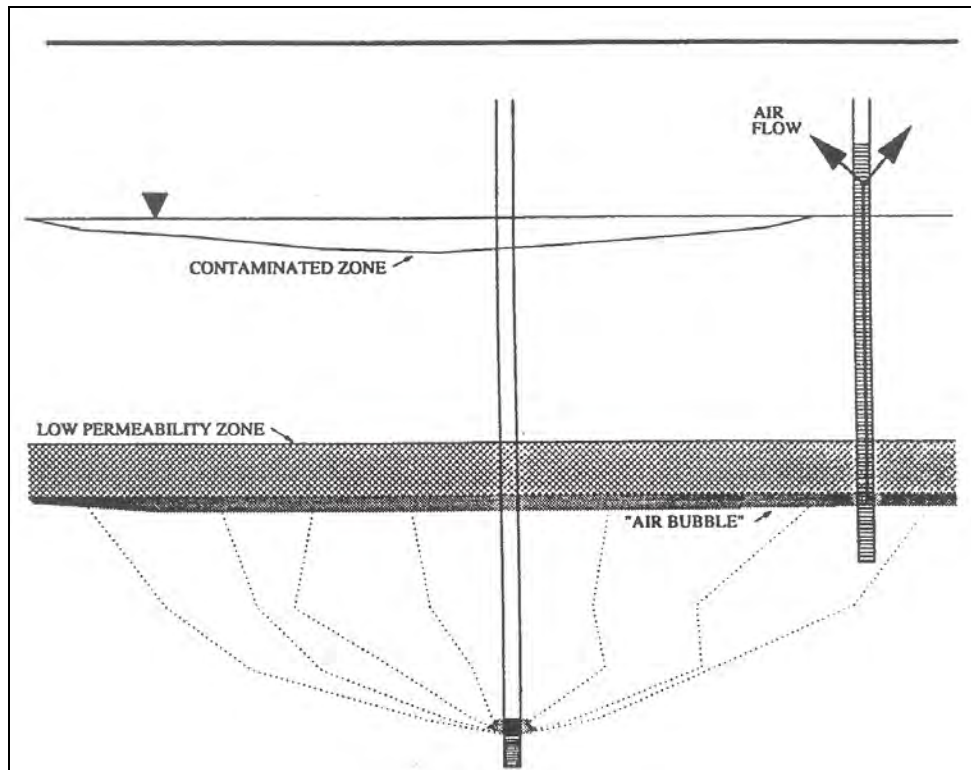

Figure 5-1. Schematic drawing showing sparged air forming an “air bubble” below a low permeability zone, and “short-circuiting” through a monitoring well, thus bypassing the zone of contamination (from Johnson et al. 1993; reprinted by permission of Ground Water Monitoring & Remediation; copyright 1995; All rights reserved.)

c. Biodegradation.

(1) There have been a number of discussions in the literature about whether air sparging operates primarily through volatilization or biodegradation. However, given the conceptual model described in Chapter 2, it is apparent that air sparging operates in both modes. Paragraphs 2-8b and 3-3e discuss many of the considerations that underlie biosparging design. In some instances, such as those sites affected by chlorinated solvents, the introduction of oxygen in air may not be sufficient to stimulate biodegradation of the target compounds if they are not readily degradable under aerobic conditions. Some form of conditioned air may be needed to promote in-situ biodegradation, or vapor-phase transport may be the only functioning removal mechanism.

(2) VOCs such as TCE, chloroform, cis- and trans-1,2-dichloroethene, and methylene chloride can be biologically co-oxidized during growth on a variety of substrates, including methane, propane, butane, and toluene (Norris 1994). Therefore, if the injected air can be conditioned with one or more of these of gases, chlorinated VOCs may be destroyed through both volatilization and biodegradation (Lombard et al. 1994).

5-3. Design Guidance—Subsurface. The mechanisms identified above provide a “general” basis for advancing the design. This chapter will provide more specific guidance for the subsurface design of IAS systems. There are many subsurface features that must be addressed during system design that are critical components of an effective IAS system. Systems should be designed to optimize volatilization and biodegradation processes and minimize adverse effects, such as uncontrolled migration of vapors or groundwater. Key features for design, along with typical ranges of values, are listed in Table 5-1. Each parameter has either been previously quantified or will be discussed in this chapter.

Table 5-1
Design Parameters for IAS Systems

Parameter	Typical Range ¹
Well diameter	2.5 to 10 cm (1 to 4 inches)
Well screen length	15 to 300 cm (0.5 to 10 ft)
Depth of top of well screen below water table	1.5 to 6 m (5 to 20 ft)
Air sparging flow rate	0.04 to 1.1 m ³ /min (1.3 to 40 scfm)
Air sparging injection overpressure ²	2 to 120 kPa (0.3 to 18 psig)
IAS ZOI	1.5 to 7.5 m (5 to 25 ft)

¹Modified from Marley and Bruell (1995).
²Overpressure is injection pressure in excess of hydrostatic pressure, P_h.

a. Airflow Rates.

(1) The airflow rate should be as high as needed to achieve an adequate air channel density, but the injection pressure should not be excessive because of the risk of causing lateral mobilization of contaminants off-site or fugitive emissions to basements, buried utilities, or the surface (Brown 1994). There is debate over what range of airflow rates is appropriate to consider during IAS system design. Wisconsin DNR (1993) recommends airflow rates of 0.08 to 0.4 m³/min (3 to 15 scfm) per IAS well, while the USEPA (1995a) recommends airflow rates from 0.08 to 0.67 m³/min (3 to 25 scfm). An API-sponsored survey of 39 IAS systems (Marley and Bruell 1995), however, report airflow rates ranging from 0.04 to 1.1 m³/min (1.3 to 40 scfm) per well, while another survey of 32 IAS systems (Bass and Brown 1996) reports airflow rates from 0.11 to 1.0 m³/min (4 to 35 scfm) per well. The Air Sparging Design Paradigm developed by the ESTCP (Leeson et al. 2002) recommends that the “Standard” IAS design use 20 cfm per well, but “Site-Specific” designs can vary. The Navy’s Air Sparging Design Guidance (Navy 2001) recommends IAS design flow rates from 6 to 20 scfm. Marley and Bruell (1995) say that higher flow rates result in increased air channel density and therefore more effective mass transfer. It is possible that more effective and rapid remediation is possible with higher per-well airflow rates

than have historically been used or recommended, provided that injection pressures are not high enough to cause soil fracturing.

(2) If capture of VOCs is required, SVE airflow rates must be sufficient to establish capture zones for the injected air. Marley and Bruell (1995) report that most practitioners ensure that the SVE airflow rate is at least twice the IAS airflow rate. Wisconsin DNR (1993) requires a minimum SVE airflow rate of four times the IAS airflow rate; however, at sites somewhat removed from buildings or subsurface structures, such criteria may be neglected.

b. Well Spacing. Well spacing should be based on the ZOI, as discussed in [paragraph 2-8a](#). As previously explained, the effectiveness of air sparging for either volatilization or bioremediation depends on the transfer of mass to or from the air channels. Diffusion of contaminants or oxygen within groundwater controls the rate of mass transfer and requires channel separations measured on the order of centimeters to decimeters to be effective. As such, good air saturation is an indicator that air channel spacing is reasonably close. It is suggested that well spacing be based on maintaining a minimum 3% three-dimensional air saturation within the target contaminated zone. Measurement of relative changes in water saturation by neutron probe or electrical resistivity tomography would support the evaluation of sparging adequacy and realistic ZOI. The “radius of influence” has commonly been used to describe the effect a sparge well has on the groundwater system. Reported IAS radius of influence values are displayed in [Figure 5-2](#). This definition has often been ambiguous in the context of air sparging, however, as it is a two-dimensional parameter applied to a three-dimensional problem (Ahlfeld et al. 1994, Johnson et al. 1995).

c. Well Screen Length and Depth.

(1) Well Screen Length. Although current research indicates that air often escapes within a very short interval near the top of the well screen, screen length may require some consideration. In the unlikely event that air-entry pressures diminish with depth along the length of well screen to a greater degree than hydrostatic pressures increase over the same depth, some fraction of the air may take deeper exits than would be expected. The result may be an increase in the ZOI, unless air is confined within a few strata.

(2) Well Screen Depth.

(a) Well screen depth for IAS is defined as the distance between the phreatic surface and the top of well screen. IAS optimal injection depths have not been evaluated rigorously. Typical top of screen depths used are between 1.5 and 4.6 m (5 and 15 ft) below the phreatic surface. Lundegard and Anderson (1996) determined through numerical modeling that, other factors being equal (e.g., no change in anisotropy), the depth of injection does not significantly change the size of the ZOI of the air plume under steady state conditions. Increased injection depth may increase the ZOI under transient conditions. The shallowest injection depth evaluated by Lundegard and Anderson was 3 m below the phreatic surface.

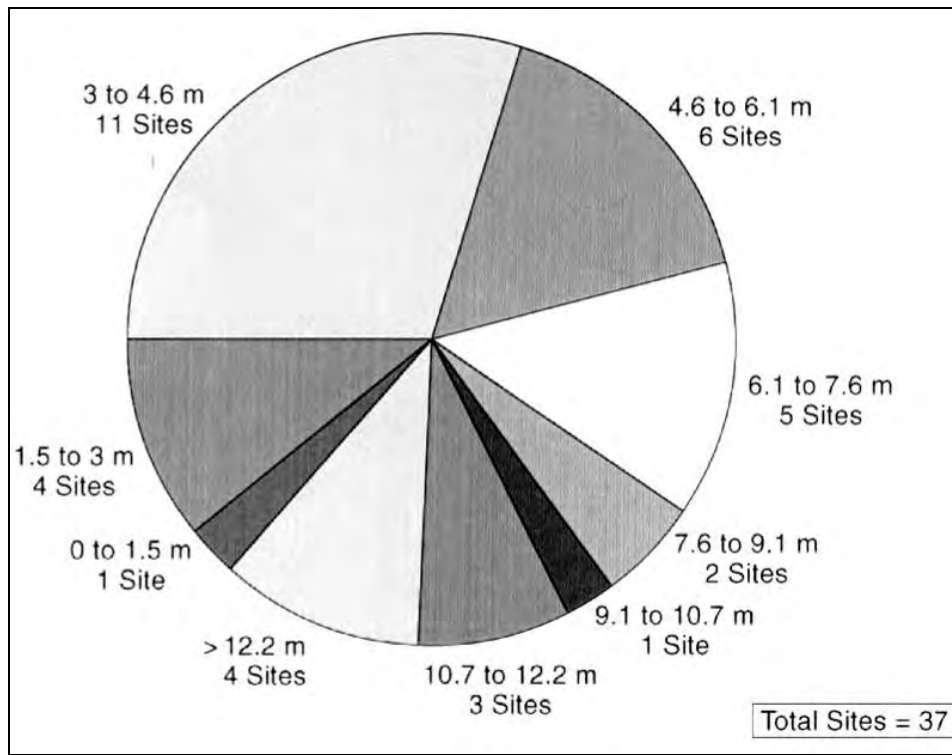

Figure 5-2. Reported in-situ air sparging radius of influence vs. number of sites (after Marley and Bruell 1995).

(b) When considering the depth of the IAS injection point, it should be noted that with increasing depth there is a trade off between the potential size of the ZOI and the possibility of flow diversion attributable to the stratigraphy. Slight changes in the depth of injection could cause a drastic change in the orientation and geometry of the air pathways and a related change in the ZOI.

(c) The primary consideration for well screen depth and placement is to match the three-dimensional contaminant distribution within the saturated zone with the three-dimensional air distribution. In cases where dissolved concentrations occur at significant depths below the water table surface, consideration should be given to focusing air injection deeper within the saturated zone. As a result, typical top of screen depths for pilot tests may in certain cases extend as deep as 15 m (50 ft) below the seasonal low water table (Marley and Bruell 1995). Bear in mind that wells screened at greater depths below the water table will have commensurately higher pressure requirements, which will affect aboveground equipment costs.

(d) Where LNAPL exists, consider applying IAS at shallower depths below the water table surface. This depth should ideally be selected based on knowledge of the location of NAPL-filled pores beneath the water table. As described in [Chapter 2](#), LNAPL may be distributed well

below the water table, depending on a variety of factors, including historical (since the LNAPL release) water table fluctuations and the pressure-head pushing the LNAPL downward during the release. Field observations of LNAPL saturation beneath the water table should be used to determine the bottom of the LNAPL zone. IAS well screens should be set based on this depth. Without this knowledge, typical top of screen depths for pilot tests are 1.5 to 6 m (5 to 20 ft) below the seasonal low water table. Note the reference made to the seasonal low water table; otherwise, the IAS well may be only seasonally useful. One strategy for setting well depths is to “customize” the screen location for each well based on field observations of LNAPL saturations in core samples when the IAS well is installed. By using knowledge from each IAS well, the IAS well network can be made appropriately specific to the site. Note that air contact with residual LNAPL is sometimes difficult to achieve, in which case the LNAPL may represent a long-term source of low concentrations of dissolved contaminants.

d. Injection and Overburden Pressures.

(1) An overpressure is an injection pressure in excess of what is needed to overcome the hydrostatic pressure imposed by the column of standing water within the sparge well (Marley and Bruell 1995). Some overpressure is required to overcome the air-entry pressure needed to displace water from within the well screen and adjacent soils (paragraph 2-6). It is important that excessive over-pressurization be avoided, however, so that the aquifer does not fracture and the system does not fail. As a general guideline, maximum injection pressures should consider the weight of the soil and fluid columns above the sparge zone, as well as a design safety factor. The following equations may be used to estimate the pressure exerted by the weight of the soil and water column overlying an IAS well screen at a given depth, with ϕ being the soil porosity and *s.g.* being specific gravity:

$$pressure_{\text{soil column}} = (depth_{\text{top well screen}}) (s.g.\text{-soil}) (1 - \phi) (9.8 \text{ kN/m}^3) \quad (5-1)$$

$$pressure_{\text{water column}} = (depth_{\text{top well screen}} - depth_{\text{water table}}) (s.g.\text{-water}) (\phi) (9.8 \text{ kN/m}^3) \quad (5-2)$$

$$total \text{ overburden pressure} = pressure_{\text{soil column}} + pressure_{\text{water column}} \quad (5-3)$$

$$max. \text{ injection pressure} = (0.6 \text{ to } 0.8) (total \text{ overburden pressure}) \quad (5-4)$$

(with a minimum safety factor of 35 kPa or 5 psig)

(2) If porosity has not been measured, it is strongly recommended that a conservative porosity of 40 to 50% be used in the above calculations (Wisconsin DNR 1993, 1995). It should be noted that although fracturing attributable to over-pressurization may cause additional macro-channels to develop and airflow rates to increase, the air–hydrocarbon mass transfer rates may actually decrease because of smaller interfacial (air–water) surface area.

(3) The following simplistic example is provided to illustrate estimation of the overburden pressure and maximum injection pressure (Wisconsin DNR 1993, Marley and Bruell 1995):

(a) Assumptions are as follows.

- Soil specific gravity of 2.7, and groundwater specific gravity of 1.0.
- Water table depth of 5.5 m below ground surface (bgs).
- IAS well screened from 9.1 to 10.7 m bgs.
- Porosity of 40% (0.40).
- Soils are homogeneous, isotropic and unconsolidated.

(b) Employing equations 5-1, 5-2, and 5-3, we estimate the overlying pressure exerted by the weight of the soil column as follows:

$$Pressure_{\text{soil column}} = \text{Weight of soil}/m^2 = (9.1 \text{ m})(2.7)(1 - 0.4)(9.8 \text{ kN}/m^3) = 144 \text{ kN}/m^2$$

$$Pressure_{\text{water column}} = \text{Weight of water}/m^2 = (9.1 \text{ m} - 5.5 \text{ m})(0.4)(9.8 \text{ kN}/m^3) = 14 \text{ kN}/m^2$$

$$\text{Total weight of soil and water}/m^2 = 144 + 14 = 158 \text{ kN}/m^2$$

$$\text{Total overburden pressure} = (158 \text{ kN}/m^2) (1 \text{ kPa}/[\text{kN}/m^2]) = 158 \text{ kPa at } 9.1 \text{ m bgs (23 psig at } 30 \text{ ft).}$$

(c) In this example, injection pressures greater than 158 kPa (23 psig) could cause system problems and secondary permeability channels to develop. Therefore, using a maximum injection pressure of 60% of the overlying pressure (i.e., a conservative safety factor of 40%), we arrive at a maximum injection pressure of 95 kPa or 14 psig for this example. Designers must remember that each site has specific conditions and requirements, should use all available information when doing these calculations (such as water table fluctuation data), and should evaluate additional geotechnical information if available.

(4) Taking both the calculated pressure data and the pilot test data into consideration, the designer can calculate the pressure necessary to deliver the desired airflow rate under all seasonal operating conditions. Professional judgment is required to determine design pressures and flow rates for each IAS well, and to balance flows among wells in a well field. In the final analysis, balancing flows will depend on factoring in system monitoring data obtained during operation (see [Chapter 6](#)). If an airflow rate of approximately 0.01 m³/min (0.4 scfm) per well cannot be maintained, the soil permeability may be too low and IAS may not be appropriate for the site.

e. Depth to Groundwater and Seasonal Variations. The depth to water and temporal variations in the piezometric surface should be evaluated prior to design. This information is necessary to assure proper screen placement and compressor selection, as the size of the compressor is largely dependent on the hydrostatic pressure associated with the standing water column. It may be necessary to complete borings with vertically discrete well screen clusters (i.e., with two screen depths) for sites with significant fluctuations in seasonal groundwater elevation.

f. Well Field Design.

(1) General. The number and placement of air injection wells should be chosen to maximize the air–water interfacial area within the zone of contamination. Well placement is derived from the anticipated ZOI determined from a site-specific pilot test. Techniques for evaluating a ZOI have been described in [Table 4-1](#). Well placement is also a function of water table depth and soil conditions (i.e., heterogeneity, classification, etc.). A typical site plan is shown as [Figure 5-3](#).

(2) System Configurations. IAS systems may be used for both source area treatment and contaminant plume control. The distribution and configuration of wells used for these purposes varies according to site constraints.

(a) Examples of IAS system configurations include:

- A linear orientation of wells perpendicular to groundwater flow direction (e.g., a sparging curtain).
- Nested wells (IAS and SVE at different depths of the same borehole) distributed throughout a plume or source area.
- Encapsulation of the contaminant plume (i.e., surrounding the plume with IAS wells).
- Horizontal IAS wells.

(b) When using sparge curtains, care must be taken in both the design and operation to ensure that sufficient contact is achieved between the sparged air and the contaminated groundwater plume passing through the curtain. To the extent that air channels cause a decrease in hydraulic conductivity and an increase in upgradient head, a sparge curtain may result in contaminated groundwater migration around the curtain. The IAS well network configuration and mode of operation should account for this possibility (see discussion of pulsing, [paragraph 6-6b](#)). Similarly, encapsulation systems must be designed and operated to account for transient groundwater mounding that will occur with the injection of sparged air.

(c) For some applications, horizontal wells can be extremely useful. Horizontal wells or sparging trenches have been used at sites with shallow aquifers, long, thin contaminant plumes, and limited-access plume areas such as under buildings or roads. Typically, fewer horizontal wells are needed but the installation costs per well are significantly higher. Furthermore, it may not be possible to prevent all the airflow from occurring at one portion of the horizontal well screen, although some notable efforts have been made (Wade 1996). Installing a series of shorter, segmented well screens, each with its own air delivery tube and separated by grouted sections, may be necessary, but is apt to be expensive. Construction of horizontal IAS wells is addressed in [paragraph 5-4c](#), as well as in USEPA (1994) and Larson (1996).

(d) If the well configuration selected only addresses a portion of the plume, groundwater extraction may be required to control lateral migration. Conversely, if IAS wells extend to the perimeter of the contaminant plume and therefore contain contaminant migration, groundwater extraction wells may not be necessary. The system designer should completely understand site conditions and choose a configuration that will effectively accomplish site-specific treatment goals.

5-4. Subsurface Construction. During IAS system operation, lateral distribution of dissolved contaminants in the saturated zone may increase because of horizontal vapor movement (Brown and Fraxedas 1991) and induction of new groundwater flow patterns (Marley and Bruell 1995). To account for this potential, monitoring wells and air sparging wells should be placed near the perimeter of the contaminated zones. Alternatively, the well system design and piping layout should be prepared for the possibility of future expansion should evidence of plume spreading arise, with capped tees to provide the capability of adding peripheral wells, if necessary. Prior to finalizing the well layout, care should be taken to locate existing utilities. IAS wells, utilities, and appurtenances should be relocated as necessary. Site access, including considerations for support facilities, storage areas and parking, should also be identified to prevent the potential release or migration of contaminants by installation equipment during construction (e.g., air-rotary drilling might push vapors into a nearby basement).

a. Vertical Sparging Wells.

(1) Casing. New polyvinyl chloride (PVC), 50 mm (2 in.) in diameter, is normally used for sparging well casing (Figure 5-4). Larger diameters may be needed to increase flow capacity, but require larger boreholes. Assess pressure drop inside well casing and screen diameters based on the pneumatic analysis procedures used for piping. Other materials may be specified if air amendments or site contaminants, at expected concentrations, are likely to be damaging to PVC. Materials with appropriate physical properties and chemical resistance may be used in place of PVC where economical. Use heat-resistant materials if thermal enhancements may be applied at the site. The casing must be strong enough to resist the expected air and grout pressures.

(2) Screen. Well screen is usually PVC with slotted or continuous wrap openings. Continuous-wrap screen is strongly preferred because the increased open area reduces the pressure drop across the screen and therefore reduces energy costs for the blower. Special “diffuser” tips that are promoted for use in lieu of conventional screens may result in a higher pressure drop for a given flow of air than conventional screens. Such diffuser tips neither result in bubble migration in the formation nor alter the flow of air through discrete channels in the formation.

(3) Filter Pack. Choose filter pack material according to methods outlined in a text such as Driscoll (1986).

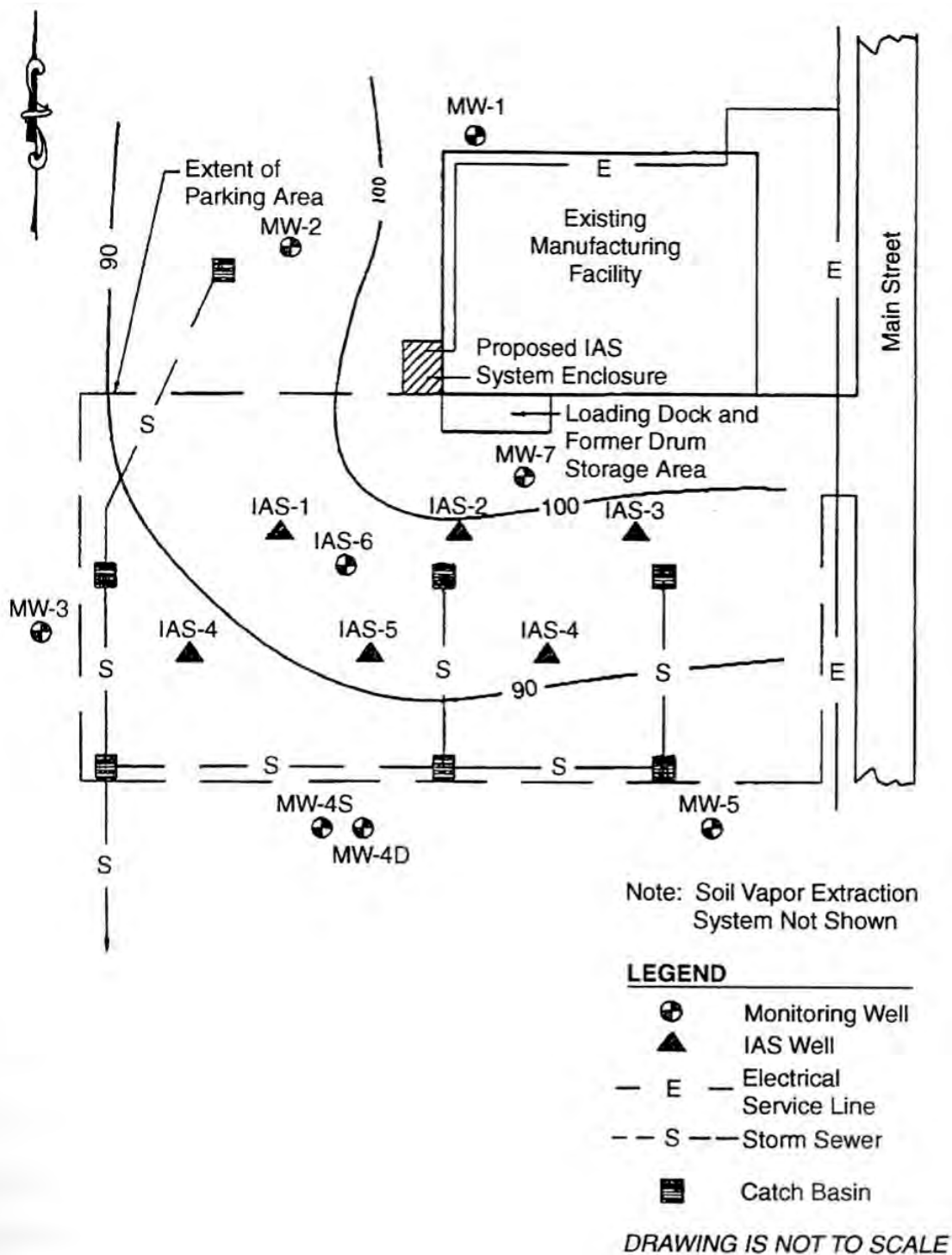
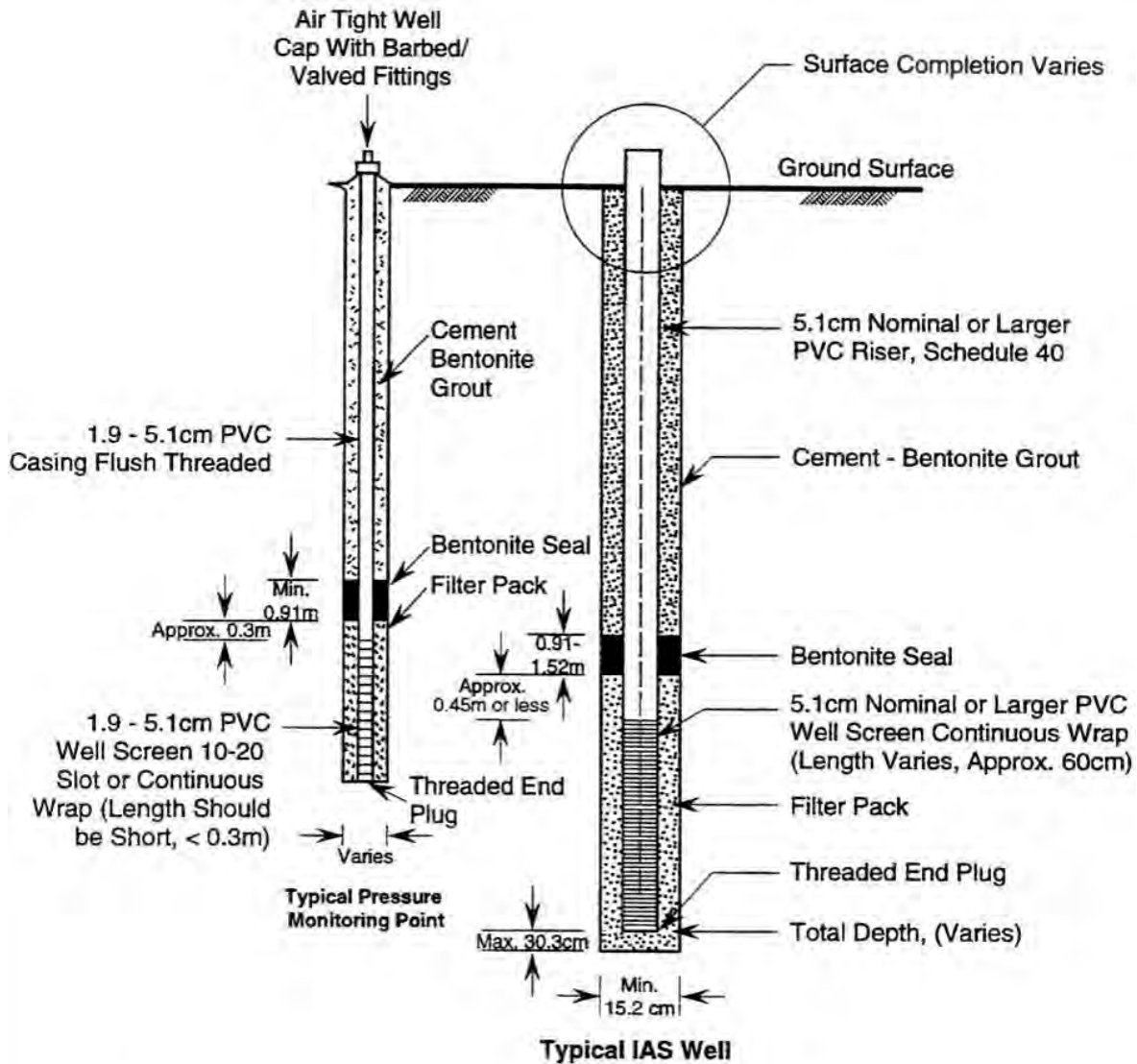

Figure 5-3. Typical IAS site plan.

(4) Seal and Grout. A well seal is necessary to prevent entry of grout into the filter pack and well screen. Unamended sodium bentonite, as pellets, granules, or a high-solids bentonite

grout, is normally specified for the seal material. A cement grout is preferred to fill the annulus above the seal to the ground surface because it resists desiccation cracking. The mixture of the grout should be specified and is normally one 42.6-kg (94-lb) bag of cement (optionally with up to 2.25 kg [5 lb] of bentonite powder to further resist cracking), with less than 18 L (5 gal.) of clean water. Reference ASTM C 150 in the specification as appropriate.



NOT TO SCALE

Figure 5-4. IAS well/monitoring point construction details.

(5) End Caps/Centralizers. Flush-threaded end caps, consistent with the casing and screen in size and material, should be specified. Centralizers center the well in the borehole and must be a size appropriate for the casing and borehole.

(6) Drilling Methods and Borehole Dimensions. There are many methods for drilling air sparging wells. Avoid methods that result in significant formation damage that may be difficult to overcome by well development. For example, some drilling methods potentially smear clay on the borehole wall. This may ultimately require elevated air injection pressures to push air into the formation or may actually alter air paths into the formation. It may be useful to sample soils at regular intervals (a frequency of 1.5 m [5 feet] is common) to evaluate stratigraphy above the water table. It is critical, however, to continuously sample soil below the water table at the depth of contamination to determine whether there are confining strata that will inhibit airflow through the contaminated soil. Materials encountered should be described according to a standard such as ASTM D 2488. Normally, the diameter of the borehole is at least 150 mm (6 in.) greater than the diameter of the casing and screen to allow placement of the filter pack. The depth of the borehole should be based on the planned screen depth. Although direct-push techniques have been used to place air sparging injection points, this method is not recommended. In some cases such placement appears to be successful; however, there is an increased risk of air leakage around the pushed point. This is especially true where significant force was required to drive the casing such that the borehole was enlarged around the casing owing to excessive deflection during placement. In addition, damage can be inflicted on the sparge points during direct-push placement (e.g., sparge point blockage with soils, screen damage). [Figure 5-5](#) shows examples of such damage for direct-push points in glacial tills. Lastly, direct-push points are more difficult to successfully develop than traditional wells. This may result in an increase in required injection pressures and, at best, higher energy costs or, at worst, unequal injection pressure, causing preferential flow into a single or a few sparge points and no flow into others. The screens in the direct-push points shown in [Figure 5-5](#) were sufficiently compromised to limit airflow, even at very high pressures, causing preferential flow into other undamaged sparge points.

(7) Well Placement and Wellhead Completion. Wells should be constructed as any other water well. Refer to EM 1110-1-4000 for typical installation techniques and requirements. The completion of the wellhead will depend on the other features of the design, such as the piping and instrumentation requirements. If there is any standing water in the well above the bentonite seal, grout needs to be tremied into place to displace that water. Fit each wellhead with both a pressure gauge and a shutoff valve, and possibly a flow-measuring device. Each well requires proper development, as described in Driscoll (1986) or USEPA (1975). Establish the horizontal coordinates of the well by survey. Survey the elevation of the top of the casing. The accuracy of the surveys depends on the project needs, but generally is to the nearest 0.3 m (1 ft) for the horizontal coordinates and the nearest 0.003 m (0.01 ft) for elevation.

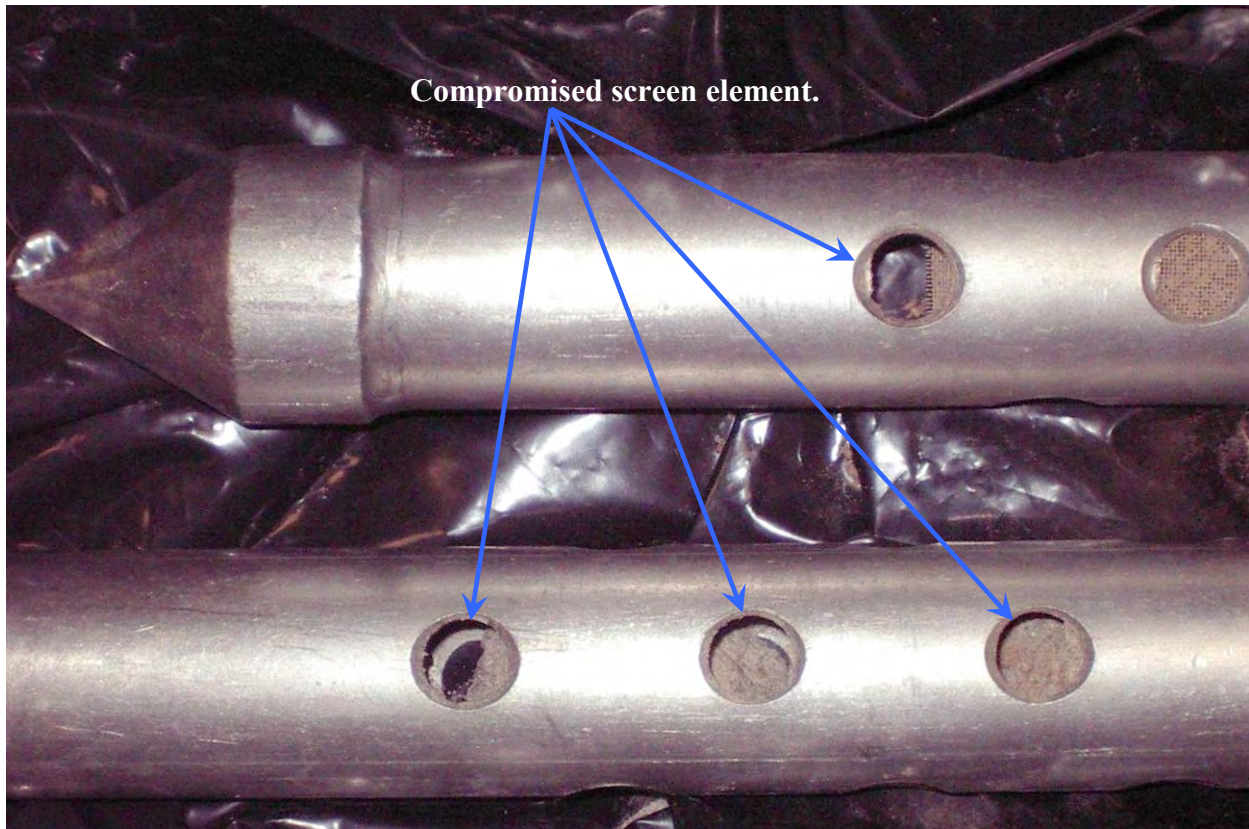

Figure 5-5. Example of “failed” direct push sparge point.

b. Soil Gas/Pressure Monitoring Points.

(1) Well Materials. Generally, the same materials can be used for the monitoring points as for the extraction wells; however, there may be a difference in size. Generally, 20- to 50-mm (3/4- to 2-in.) diameter PVC pipe is used. Flush-threaded pipe is preferred, but for smaller diameters, couplings may be needed. Either slotted or continuous-wrap screen can be specified. Slotted pipe is adequate for monitoring points. Other screen types can be used. Options include slotted drive points and porous points. Keep screen length to a minimum to avoid air short-circuiting long vertical distances through the screened interval. Filter pack material, if required, should be appropriately sized for the screen slot width.

(2) Installation. Although a hollow-stem auger is still the primary means of installing monitoring points, direct-push methods can also be used to place slotted drive points or other pressure or soil gas probes at specific depths. Sample the materials encountered for logging and physical and chemical testing. The borehole diameter should be approximately 101 mm (4 in.) larger than the screen and casing to allow placement of the filter pack. This obviously would not apply to points placed by direct-push methods. Monitoring point depth selection is entirely site dependent, but monitoring of multiple depths within the zone to be monitored is recommended. Casing, screen, and annular material are normally placed by methods similar to those used to in-

stall sparging wells; however, direct-push techniques are rapid alternatives for placing monitoring points to the desired depths. Actual means of placement depends on the system, materials used, and site geology.

(3) Surface Completion. Complete the monitoring points with a suitable barbed or valved sampling port or septum attached by threaded connection to an appropriate end cap. Attach the cap to the top of the casing by an airtight connection. The points can be set above grade with suitable protection or below grade, typically in a flush-mount valve box. Survey each monitoring point to same accuracy as the air sparging wells.

c. Horizontal Wells.

(1) Horizontal wells can be used for sparging provided adequate steps are taken to assure uniform air delivery. Pay careful attention to the vertical well alignment to avoid preferential air injection at high spots (which have lower hydrostatic pressures) in the screen. Avoid using drain pipe wrapped with geotextile or other filter-like materials because of the potential for fine material to plug the openings. Perforated piping is more difficult to develop and rehabilitate than continuous slot screen. Prepacked, continuous-slot screens have been successfully used in sparging applications. There are porous materials, including porous sintered polyethylene, that have also been used very successfully as screen and filter pack in horizontal wells. Refer to USEPA (1994) for additional design guidance.

(2) Successful use of horizontal wells has been documented at a number of site locations, including the Department of Energy's Savannah River site (USDOE 1995), a formerly used Defense site near Hastings, Nebraska, as documented by the U.S. Army Engineer District, Kansas City (Siegwald et al. 1996), and the Guadalupe Oil Field in central California. At the Savannah River and Hastings sites, the horizontal wells involved sparging sections over 60 m (200 ft) long. Air distribution was good in both cases. In the Hastings project, special tubing runs were terminated within different sections of the horizontal run to verify full displacement of water by air within the well. The chlorinated organic plume being treated at the Hastings site apparently began to migrate around the ends of the sparging curtain. Groundwater flow models calibrated to water levels observed during sparging suggested that formation transmissivity was reduced by over 50% because of the creation of air-filled porosity. At both the Savannah River and Hastings site, a horizontal well was used for injection of air, methane, nitrous oxide, and triethyl phosphate into the saturated zone to enhance co-metabolic bioremediation of chlorinated organics. At the Guadalupe site, the horizontal well was 58 m (190 ft) long with a 15 m (50 ft) long screen. This well was installed in relatively uniform eolian dune sand, and carefully monitored during a 6-day pilot test. Electrical resistance tomography (ERT) results showed that there was uniform airflow from the entire screen into the formation. However, the ERT data indicated that the airflow was confined to within 1.5 m (5 ft) of the well. Dissolved oxygen data indicated that the influence of the well was limited to a 2.3 m (7.5 ft) region on either side of the well axis.

d. Sparge Trenches. Sparging trenches can be used effectively at sites with shallow contaminated groundwater or as the treatment gate in a funnel and gate system. The placement of a sparging trench can be accomplished by several methods including normal excavation or trenching machines (which excavate and place pipe and filter pack in one pass). [Figure 5-6](#) illustrates a typical sparging trench.

(1) Construction Materials. Although PVC casing is commonly used, flexible or rigid polyethylene pipe may be more efficient for certain excavation methods, such as trenching machines. The pipe must resist the crushing pressures of the backfill and compaction equipment. Screen can consist of slotted pipe, continuous slot screen, or porous material. The guidance for specifying filter pack in vertical sparging wells may be applied for trenches, but somewhat coarser material may be needed for a secure bedding and cover for the pipe and screen. For treatment gates, use uniform coarse material which has typical pore sizes larger than 2 mm. This results in bubble flow, rather than channel flow, and higher mass transfer efficiency. Coarse material (uniform coarse sand or gravel) also provides a high hydraulic conductivity during sparging and assures adequate flow capacity for a treatment gate. Native material may be used as backfill above the filter pack in an excavated sparging trench. Coarse filter pack material may extend into the unsaturated zone especially if there is an overlying SVE system.

(2) Excavation and Placement Methods. Methods used to install sparging trenches include many standard earth-excavating equipment (e.g., backhoe) and trenching machines. Given this wide variety, it may be desirable to specify only the pipe, screen, pack materials, and an ultimate pipe alignment and depth. The trenching technique used by the contractor must provide an adequate filter placement around the collector pipe. Dewatering or shoring will be required in most cases. Compliance with Occupation Safety and Health Administration and USACE safety requirements is mandatory. Piping and screen placement is very similar to placement of piping for underground utilities and leach fields. Refer to ASTM F481.

5-5. Manifold and Instrumentation Design.

a. General.

(1) [Figure 5-7](#) is a schematic diagram that includes a typical IAS piping and instrumentation diagram (P&ID).

(a) IAS manifold components commonly include the following.

- Pressure, flow, and temperature gauges.
- Pressure relief valve or bypass line.
- Excess air bleed valves.
- Throttle valves.
- Manifold piping or hose.

- Check valves.
- Optionally, solenoid valves and sample ports (to enable groundwater sampling to check for rebound at later times).

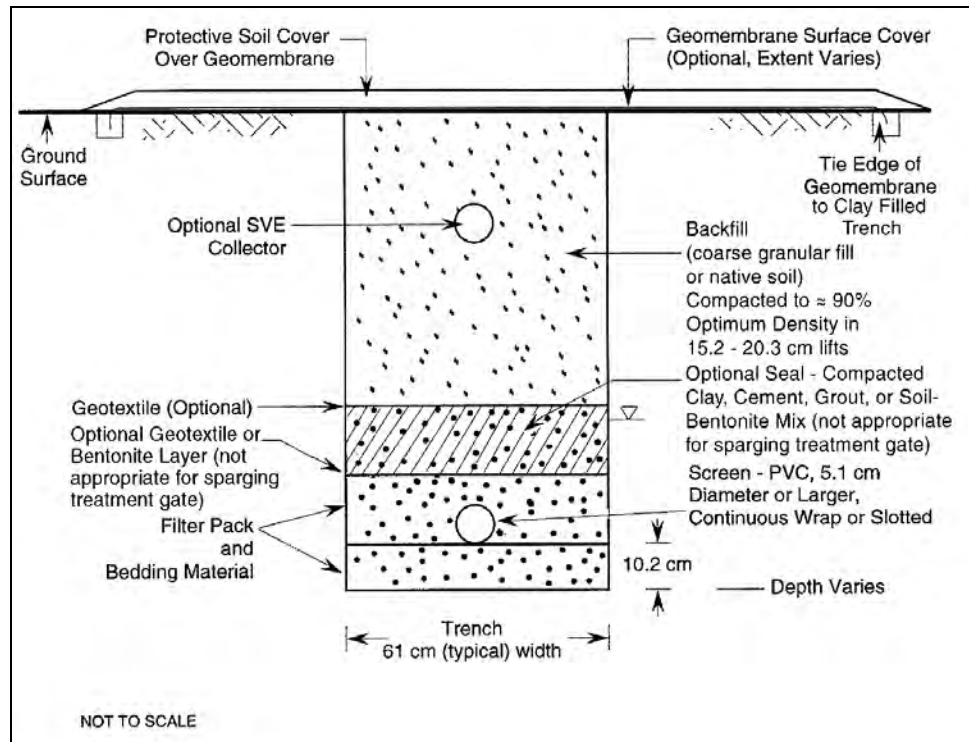

Figure 5-6. Typical horizontal IAS well design.

(b) Each of these components is discussed below. The piping system can be designed for installation either above or below the ground surface, depending on the traffic requirements of the area and the need for adequate protection against frost.

(2) [Table 5-2](#) provides an example of the control logic that might be used with the system shown in [Figure 5-7](#). When designing an IAS system, site specific factors dictate the types of control features and the degree of system automation. Systems that have a full-time operator are monitored and controlled differently than are remote systems that only get infrequent O&M visits. [Table 5-2](#) references a system controller with autodialer that is used to relay system data to the operator, such as abnormally high pressure in the sparge manifold indicating blockage in the piping. Development of control logic, as shown in this table, is required to complete an IAS design.

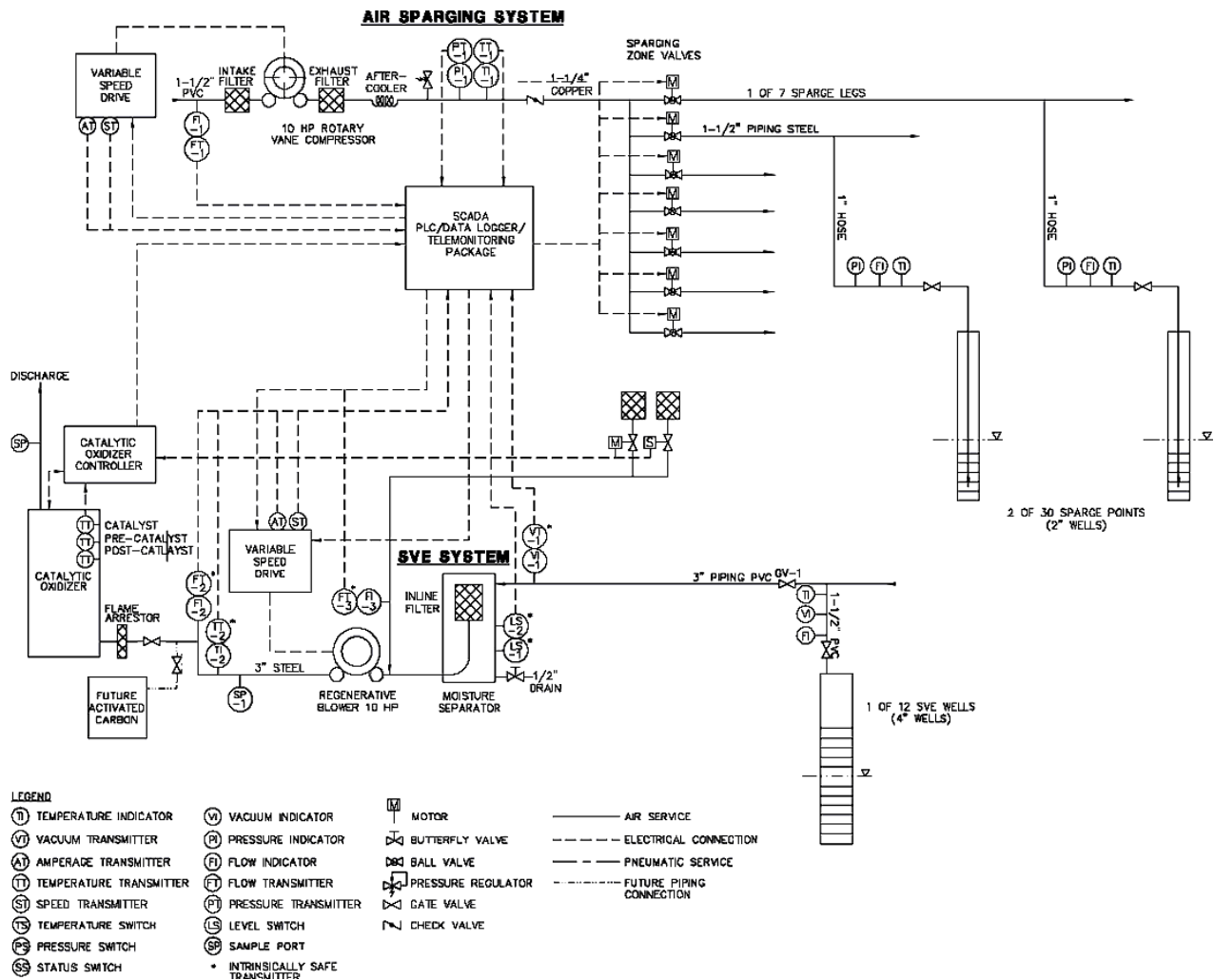

Figure 5-7. Example IAS and SVE piping and instrumentation diagram for an IAS system with 30 IAS wells on 7 “headers” or “legs” and 12 SVE wells.

b. Design and Installation of the IAS Manifold. Beginning at the outlet of the air supply source (typically a compressor, blower or gas cylinder), compatible materials are connected to supply headers for the IAS wells. Typical manifold construction materials include metal piping, rubber hose, or ABS pipe. PVC pipe, although in common use, is not recommended by manufacturers for above-ground air pressure service. PVC pipe is acceptable for below ground installation as long as it is strong enough to resist maximum air pressures. Pipe sizes are flow and pressure dependent; see EM 1110-1-4001 for pipe sizing. Design for installation of plastic pipe above grade should have provisions for movement ascribable to thermal expansion and contraction in accordance with Plastics Pipe Institute (PPI) TR-21(2001).

(1) Prior to routing to individual IAS well supply, permanent pressure and temperature gauges and switches, along with an air flow meter, are installed for quick visual measurements during routine system checks. They are also installed potentially for interlock connection to the

electrical supply in case the system does not conform to specified operating conditions. These permanent measurement devices should be installed in accordance with the manufacturer's recommendations for length of unobstructed flow, etc. A pressure relief valve (manual or automatic) or system bypass line should be installed to exhaust excess pressure from the manifold. This will prevent excessive pressure that could cause damage to the manifold or aquifer. Exhaust air can be directed to the atmosphere or to the air source intake. A silencer for the blower or compressor exhaust should be considered, based on site conditions and air velocities.

(2) A header from the manifold to each well must be designed (Figures 5-8 and 5-9). The designer must evaluate all reasonable construction options for piping materials and the associated costs to determine the most effective air delivery system to each IAS well. Once the piping materials are selected, each well should have a throttle valve, check valve, temporary ports for flow, pressure and temperature measurements, groundwater sampling port and, optionally, a solenoid valve. The throttle valve is used to adjust airflow or to isolate a well from the manifold system. Typical throttle valves used are gate, globe, butterfly, or ball valves. Check valves are installed on each well to prevent temporary back-pressure in the screened interval of the aquifer from forcing air and water up into the manifold system when airflow to a well ceases (Marley and Bruell 1995). Check valves are also very important for minimizing the mobilization of silt towards the IAS well from backpressure when airflow ceases, particularly during pulsed operation. If the system is not pulsed, but rather operates continuously, and a check valve is not installed on each well, then a single check valve should be located on the manifold line between the permanent instrumentation and the gas pressure source.

(3) One or more ports that can be used for temporary measurements of airflow, pressure, and temperature are recommended for system-optimizing adjustments during operations. Solenoid valves are optional features and their use is dictated by the system operating and control strategy. If pulsed operation of the system is anticipated for more effective remediation or reduced energy consumption (discussed in more detail in paragraph 6-6b), solenoid valves should be installed for individual well activation and deactivation. Timers, either analog or programmable logic control (PLC), can be employed to control solenoid valves as desired. It should be noted that check and solenoid valves may significantly restrict air flow or generate significant line pressure drops. The pressure drop across these appurtenances, if they are used, must be accounted for when sizing manifold piping. Also, all manifold instruments should be constructed with quick-connect couplings for ease of maintenance and removal.

Table 5-2
Instrumentation and Control Logic for Example IAS and SVE System

Motor, Valve or Switch	Control Logic	Signal to Autodialer
SVE vacuum blower motor	If vacuum blower motor ceases operating, de-energize IAS compressor motor and catalytic oxidizer (unless catalytic oxidizer has an internal flow sensor to perform identical function)	If vacuum blower motor stops operating, notify operator via autodialer
Catalytic oxidizer thermal safety switch	If catalytic oxidizers units stop, de-energize SVE blower	If catalytic oxidizer stops operating, notify operator via autodialer
IAS compressor motor	none	If IAS compressor motor stops operating, notify operator via autodialer
Low pressure switch on IAS compressor outlet	If pressure is too low (indicating a piping leak or that the pressure relief valve has released), de-energize IAS compressor motor	If pressure is low (indicating no or low flow), notify operator via autodialer
High water level switch in water knock-out tank	If high water level switch makes contact, de-energize SVE blower motor	If water level is high, notify operator via autodialer
Low vacuum (high pressure) switch prior to SVE blower	If vacuum is low (indicating leak in SVE piping), de-energize SVE blower motor	If low vacuum (high pressure) switch is triggered, notify operator via autodialer
Low pressure switch after SVE blower	If pressure is low (indicating leak in piping to catalytic oxidizer), de-energize SVE blower motor	If low pressure switch is triggered, notify operator via autodialer
Vacuum relief valve prior to SVE blower	Allows ambient air to be drawn in if clogging in SVE occurs	None
Pressure relief valve on outlet of IAS compressor	Releases compressed air if IAS lines become clogged	None

(4) The manifold that supplies air to each IAS well is often installed underground, below the site's frost line. Above-ground installation designs should be reviewed for items such as shock load and potential vehicular damage. All construction, including excavation, trench bottom preparation, and backfilling and compaction should be done in accordance with industry accepted standards. The manifold sizing is site specific and depends on factors such as airflow rates, pressure losses, material costs, and line distribution patterns. As stated above, although often considered convenient for short-term tests, PVC is neither intended nor recommended for above-ground air pressure service. All piping should be installed in accordance with the manufacturer's recommendations. If rubber hose or ABS pipe is used, tracing tape or other appropriate material that can be detected by a metal detector should be included after the installation is completed for future location. Once the manifold has been completed to each well, high pressure air hose or hard pipe, accompanied with couplings and plugs, can be used to secure the manifold to the well header (Marley and Bruell 1995). Care must be taken to ensure that the pressure drop through this connection is accounted for by using manufacturer recommended friction loss factors when calculating the minimum pipe diameter.

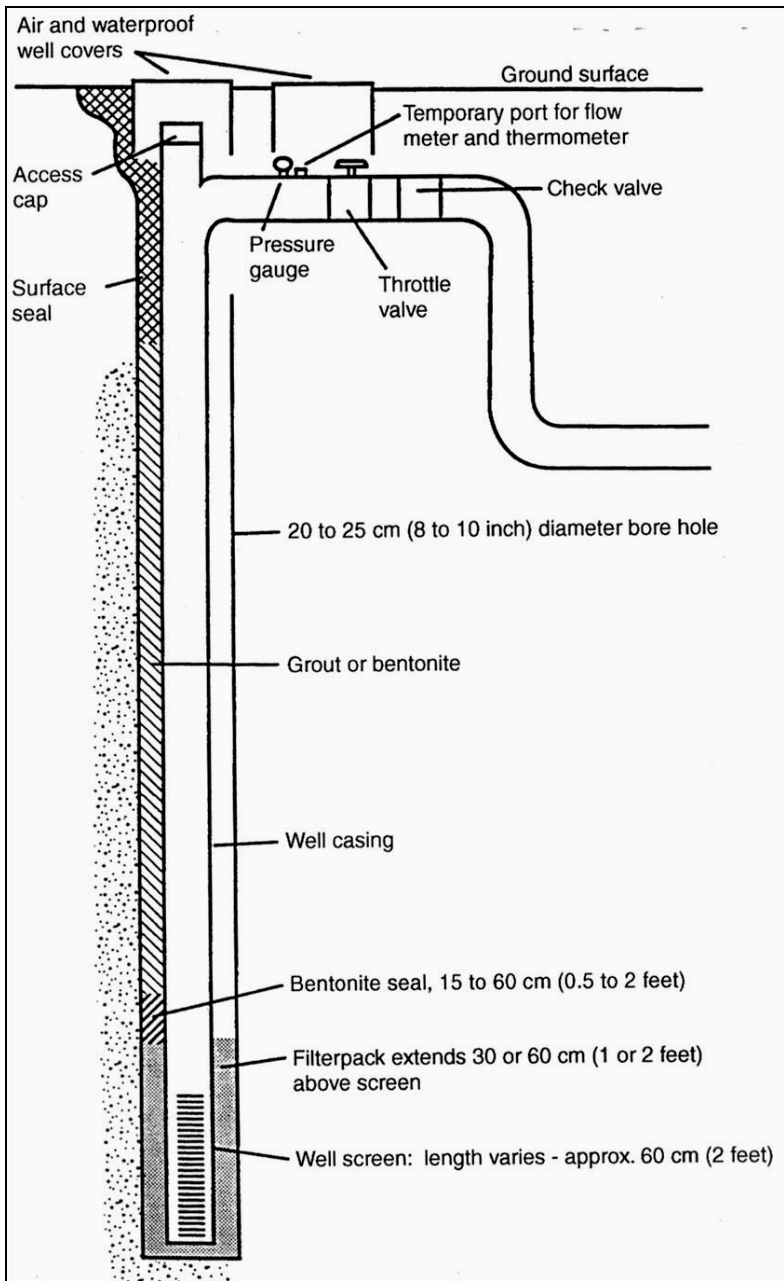

Figure 5-8. Typical air sparging well design and wellhead completion (after Wisconsin DNR 1993).

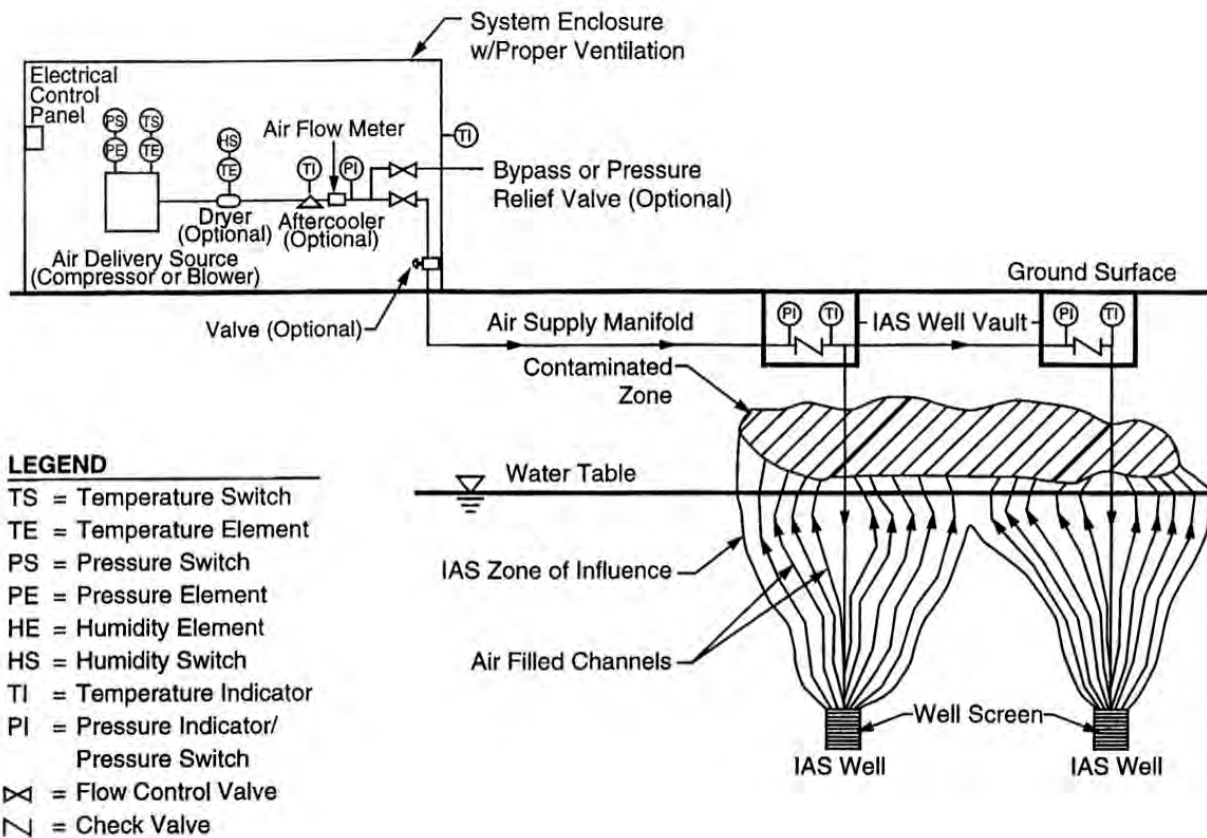

Figure 5-9. Typical IAS preliminary system diagram. At this site the contamination resides largely within the capillary fringe.

5-6. Air Delivery Equipment Design.

a. General. Air delivery sources are designed based on system requirements developed from pilot tests, and based on design calculations of required minimum pressures attributable to hydrostatic head, air-entry pressure head, and manifold losses. When the total system design calculations are completed and pilot test data are reviewed, the optimum pressure and flow for each well is determined for the site-specific geological and physical domain. The air supply is typically delivered by either an air compressor or blower.

b. Unit Selection.

(1) The first consideration when beginning calculations for operating pressures is to avoid excessive pressures that could cause system to malfunction or create secondary permeability in the aquifer. To begin to estimate minimum and maximum air pressures required for operation, the designer should assume that the pressure must at least equal the hydrostatic pressure at the top of the well screen plus the air-entry pressure required to overcome capillary forces. Calculating the hydrostatic pressure further down on the well screen will be necessary if the

designer wants to take advantage of more of the screen, air entry pressures notwithstanding. For calculating the minimum required system operating pressure, the designer should use the common conversion (equation 2-2) that each foot below the water table equals 0.43 psig of hydrostatic pressure (or equivalently, that each meter equals 9.74 kPa), and add the estimated air-entry pressure, yielding the minimum operational pressure required. The designer should be careful to consider water table fluctuations when estimating the top of screen depth below the water table.

(2) [Table 5-3](#) summarizes the features of various types of air delivery equipment. When selecting air delivery equipment, the unit must be capable of producing pressures sufficient to depress the water table in all IAS wells below the top of the screen and deliver the required air flow to each well. Additional considerations, such as explosion-proof equipment, silencers, dryers, filters, and air coolers, are discussed below. Common air delivery sources, along with a brief explanation of mechanical and operational considerations and the interrelationship with the design variables, are listed below. The designer should select air delivery equipment whose pump curves indicate that the unit will operate efficiently within the design pressure and flow ranges. As with any equipment selection, the designer should contact the vendors or manufacturers and review performance curves (i.e., blower curves) prior to specification. All units should be rated for continuous duty.

(a) Reciprocating Piston Air Compressors. These units are used when the application calls for high pressures (e.g., for an IAS well screened at considerable depth below the water table); however, they generally deliver a relatively low flow rate. Only oil-less units should be specified to ensure that lubrication oils are not injected into the subsurface if there is a mechanical failure. These units are capable of producing substantial pressures that could cause manifold problems. Therefore, the designer should install an automatic pressure relief valve on the air compressor outlet if this type of unit is specified. Please note that reciprocating compressors can be expensive.

(b) Rotary Screw Air Compressor. While providing a wider range of capability (up to 1100 kPa [160 psig] at moderate flow rates) for IAS service, these units typically contain oil, which could accidentally be discharged into the subsurface. Therefore, a filter should be employed to ensure removal of any oil in the air compressor outlet. These units are acceptable for IAS service but may be more expensive and require more maintenance than reciprocating compressor units.

(c) Regenerative Blowers. Regenerative blowers are used for typical low pressure applications of up to 70 kPa (10 psig) (i.e., sites conducive to air flow at low pressures). They are more often used for creating high flows at low vacuums for SVE applications than for IAS injection. There are several advantages associated with using these units, including low capital cost, low maintenance, and oil-free air delivery. If higher pressures are required, a multi-stage blower system may be used.

Table 5-3
Typical IAS Air Delivery Equipment

Compressor/blower type	Maximum pressure range	Typical capacity per motor size	Features
Reciprocating piston air compressor	100–125 psi	2 hp, same unit: 10 cfm @ 16 psi 7 cfm @ 100 psi	-useful for deep sparging or with tight soils -relatively constant flow through a wide pressure range -long service-free life -relatively high air pulsations -loud -low flow -high pressure
Rotary screw air compressor	100–175 psi	7.5 hp, same unit: 32 cfm @ 100 psi 23 cfm @ 150 psi	-useful for deep sparging or with tight soils -moderate flow at high pressures -oil lubricated - potential for oil discharge -very high flow units available -quieter than other types
Regenerative blower	5–10 psi	5 hp, same unit: 60 cfm @ 5 psi 40 cfm @ 8 psi	-more often used for SVE than IAS -relatively less expensive -flow decreases as higher pressures needed -no preventive maintenance required -no air pulsations -very high flow rates possible -relatively inexpensive
Rotary Lobe blowers	10–15 psi	5 hp, by changing rotational speed: 130 cfm @ 6 psi 60 cfm @ 10 psi	-more often used for SVE -flow can only be changed by changing motors, chassis, or belt drive -relatively constant flow and pressure with fixed speed motor
Rotary vane compressors	15–20 psi	5 hp, same unit: 30 cfm @ 10 psi 35 cfm @ 5 psi	-most common unit for IAS -quieter than other types -oil lubricated models need oil filtration -oil less models may need filtration of carbon dust -rather flat pressure/flow curve (i.e., similar flow @ a range of pressures) -10K–20K hr service-free operation

(d) Rotary Lobe Blowers. These units are typically capable of producing up to 100 kPa (15 psig) service. The units may have an oil-filled gear case and should use a filter for oil removal as necessary. If higher pressures are required, a multi-stage blower system may be used. Advantages of this type of equipment include low maintenance and flexibility of operating pressure range by adjustment of belt drives to modify the blower speed.

(e) Rotary Vane Compressors. These compressors are very often used for IAS applications and are available in oil-less or lubricated models. They develop pressure by having sliding flat vanes in an eccentric-mounted rotor that are flung outward against the bore of the pump. Typical maximum air pressures are in a medium range of 100–135 kPa (15–20 psig). While different size compressors are available for a range of flows, the flow generated by a specific unit does not vary greatly against varying pressure heads.

(f) Considerations Common to all Blowers. Air is usually supplied to the specified compressor or blower unit from an ambient air intake. It may be necessary to install an inlet

filter to remove particulate matter based on the location of the intake. If possible, the unit should be located away from possible contaminant sources (including soil venting systems). Non-explosion proof equipment may be used if the unit and appurtenances are located in a safe environment. Local electrical and building inspectors may require the use of explosion proof equipment for a particular site.

(3) Compression of air can generate a significant amount of noise and heat. A silencer or appropriate noise controls should be considered for all applications, especially in noise sensitive conditions. Excess noise can typically be reduced to acceptable levels through the proper application of standard noise reduction materials in equipment housing areas. Refer to EM 1110-1-4001 for further guidance. Additionally, as part of the system design, anticipated system exhaust temperatures should be calculated to ensure that discharge piping is able to withstand the compression discharge temperature and pressures. All discharge piping should be properly anchored to overcome pressure forces generated from the unit. The air injection discharge should have temperature and pressure elements and switches that are interlocked into the electrical control panel for automatic shutdown when the pressure or temperature exceeds safe operating criteria. An aftercooler can be used to reduce the discharge temperature to acceptable levels before it enters into manifold systems.

5-7. Power Distribution and Controls.

a. Electrical Service and Single-Line Diagram. Electrical service needs for the IAS system should be planned at the beginning of the design phase. The design philosophy must emphasize technical requirements, safety, flexibility, and accessibility for operation and maintenance. All electrical work must be done by licensed contractors and in accordance with all applicable codes and standards, including the National Electric Code and local requirements. If there is a potential for vapors to accumulate, show NFPA 70 hazardous area classification on the drawings. It is necessary to identify the existing service voltage to project the loads for motors and equipment. The loads are then noted with the use of a single-line diagram. Planning should include anticipating future power needs that might be required (e.g., if the system might be expanded). The single-line diagram is an excellent tool to communicate the power needs to the electrical utility company, or in the case of an industrial setting, to communicate with the plant electricians. The single-line diagram, also called one-line diagram, graphically depicts the power requirements of each load device of the system. If a separate or new electric service is necessary, the electrical utility will have to determine if capacity exists on their existing transformer or whether a new transformer is required. The requirements and cost for a new transformer are a function of project electrical power to be consumed over the duration of the project. Consulting a local electrician and the electrical utility during the beginning of the design phase will ensure that equipment selected is suited to the available power. [Figure 5-10](#) is an example of a preliminary single-line diagram for the example P&ID ([Figure 5-7](#)).

b. Control Systems. An integral aspect of the system design is considering operational controls and contingencies. System controls are site specific and may include items such as

automatic shutdown devices if operational design exceedances are encountered (e.g., temperature or pressure), programmable logic control (PLC) operation of solenoid valves during system cycling, and system shutdown owing to high water levels in SVE knockout pots. Exterior warning lights, alarms and telemonitoring may be part of the system controls. It is useful to develop the system control logic during the early stages of design to ensure that the system P&ID includes all of the relevant controls and monitoring devices.

c. SCADA. Supervisory Control and Data Acquisition (SCADA) is the combination of the controls of a PLC, telemonitoring, and data logging. SCADA systems may increase the capital costs for IAS systems over more conventional control systems. However, these costs are typically recovered during system O&M through reduced downtime and increased maintenance efficiency. In the event of system failures, the SCADA package will notify of the failure, and personnel can remotely (e.g., from the office) communicate with the site to download data collected prior to the failure. The data can be analyzed to find the events that led up to the failure. The problem can sometimes be remedied remotely by modifying system operating or control parameters. If not, then a better-informed technician can visit the site to remedy the failure with appropriate equipment and replacement parts. Other benefits of the SCADA package include data collection used to help prepare reports on system operation and performance. The data can also provide insight for optimizing system performance.

d. Low-Voltage Control Strategy. Remote remediation systems are typically visited by a technician on a weekly to monthly schedule. The technician visiting and maintaining the site will have a multidiscipline background. Often, the technician's first order of expertise will not be electrical controls; therefore, a useful strategy for IAS systems is to implement a low-voltage SCADA control center. A low-voltage (e.g., 24-V) panel will minimize the technician's exposure to dangerous voltages, and yet allow for a qualified technician to open the SCADA panel to troubleshoot. This low voltage SCADA panel can interface to high voltage control panels, motor starter, or variable frequency drives. The specification and strategy for a SCADA panel electrically isolated from voltages above 30 V must be conveyed to the equipment manufacturer or fabricator during the bid process. Not all equipment manufacturers will have built IAS systems with a strategy of panel isolation of low control voltage and power voltage. This strategy of safety is even more important with the use of 480-V power.

e. Variable Frequency Drives. A typical IAS blower or compressor is driven by an AC motor that operates at a fixed frequency (the North American standard is 60 Hz), and consequently the blower or compressor motor rotates at a fixed frequency. Therefore, a typical blower or compressor has a simple pressure to flow relationship (the "blower curve") where the blower or compressor can only produce a single pressure for a desired flow rate. A variable frequency drive (VFD) can provide AC electrical output to a three-phase inductive electrical motor over a range of frequencies, thus allowing for different motor speeds and different flow/pressure relationships for a given sparge blower or compressor. Thus, a single blower/compressor driven by a VFD can satisfy varying requirements for air sparging flow rates and pressures. The VFD provides code-required motor thermal protection, local control on motor operation and motor speed, and can allow for phase conversion from single-phase power input to three-phase motor opera-

tion (if three-phase power is unavailable). Advances in technology and increased production over the past decade have lowered costs for VFDs to levels that make them worth considering for many air sparging applications, including use on pilot test skids; use at sites with sparge wells that have significantly varying air entry pressures owing to differences in soil types or well screen depths; and use on sites expected to shrink in size as remediation progresses. Another advantage of VFDs applied to sparge blowers or compressors is an energy savings over fixed-rpm delivery equipment that relies on energy-wasting flow and pressure control by throttling or “dumping air” (regularly releasing pressure to the atmosphere). VFDs also eliminate high amperage motor startups.

f. Zone Valve Controls. As presented in [paragraph 6-6](#), air injection to sparge wells continuously is not recommended for achieving even air dispersion and good surface area contact of sparged air to the aquifer. It is best if sparge wells are “pulsed” or cycled from receiving pressure and flow to a period of resting. Rather than cycling the air delivery system on and off, it is more desirable to use zone valves on a timer to cycle the flow to the individual wells. With multiple zones, the air delivery system can be sized to the demands of wells on each individual zone, rather than to all of the IAS wells at one time. If the number of sparge valves is limited to two zones, then a single asymmetrical timer relay can be used to turn one valve on while the other is turned off. For more than two sparge zones, either the programmable logic controller (or SCADA), if used, requires internal programming or else separate sequencer timers have to be used. Lawn sprinkler sequencer timers can be used to inexpensively provide the cycling logic from zone to zone. Sprinkler timers are intended to start a process of beginning a cycle on the first zone for a programmed period, then switching to a subsequent zone for their programmed period. The lawn sprinkler sequencers are easily understood and programmed, but typically do not perform the function of beginning the cycle anew after the end of the sequence. The sequencer will require an external module to initiate it after the end of the sequence. Additional relays may be required in a zone valve control to allow for some “open-valve” overlap of two sequential zone valves. With both zone valves open (i.e., open-valve overlap), the opening and closing valves may result in a high restriction in the pipe, resulting in a higher pressure than allowed with the air delivery equipment.

5-8. System Appurtenances.

a. Heaters. Heaters may be used to warm injected air delivered to the IAS wells (Wisconsin DNR 1993). The heat added during compression should be sufficient to maintain the injection air temperature above the natural groundwater temperature. Additional heat may be required for low pressure systems during the winter or in cases where significant manifold piping is exposed to subfreezing conditions. The designer should determine whether direct-fired heaters that inject air that is reduced in oxygen content will have a negative effect on remediation by biodegradation. Electric heater elements may be used to add heat to the injected air. An advantage of electric heat over direct-fired heaters is ease of installation and elimination of the use of a gas fuel or liquid fuel and the related infrastructure. A disadvantage of electric heat is that energy costs are typically two to three times that of gas or liquid fuels.

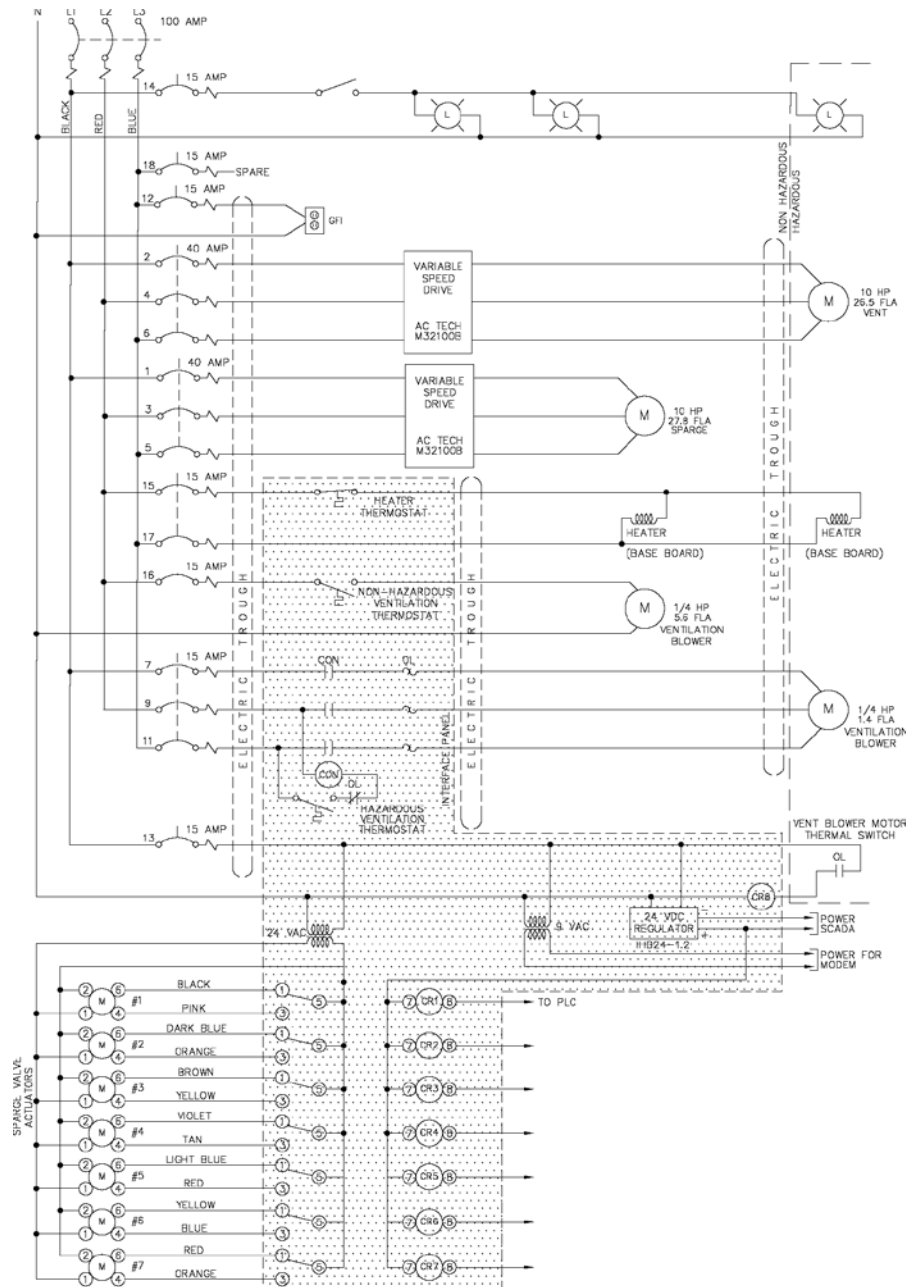

Figure 5-10. Example preliminary single-line diagram for the IAS/SVE system depicted in Figure 5-7.

b. Injection of Gases Other Than Air. There are a variety of gases other than air that can be introduced into the subsurface through the use of an IAS system. These other gases include enriched oxygen or ozone streams instead of air to attempt to achieve higher dissolved oxygen concentrations. (Note: The solubility of oxygen in groundwater in equilibrium with atmospheric air is approximately 10.1 mg/L at 15°C, while the theoretical solubility of oxygen in groundwater in equilibrium with pure oxygen is 48 mg/L at the same temperature. However, once the sum of the partial pressures of all of the dissolved gases in groundwater exceeds the groundwater

pressure, gases tend to come out of solution and form bubbles. Thus, it is uncommon to achieve groundwater DO concentrations significantly greater than 10 mg/L.) At sites containing high concentrations of dissolved iron, the designer should consider the possibility that when delivering more concentrated forms of oxidant, such as pure oxygen, faster precipitation or plugging of the soil may occur. Also, as pure oxygen and ozone are highly reactive substances, the design team must ensure that all mechanical equipment and piping in direct contact with the oxygen or ozone is specifically rated for use in this environment.

(1) In addition to alternate electron acceptors, gases that promote co-metabolic bioremediation can be delivered by an in-situ sparging system. As described previously, some aerobic bacteria can biodegrade chlorinated solvents such as TCE, DCE, and vinyl chloride if supplied with methane or propane and oxygen. Hazen et al. (1994) have demonstrated that biosparging with a mixture of methane in air can promote in-situ biodegradation of these compounds in aquifers that contain methanotrophic bacteria. When designing such a system, it is critical that the designer ensure that the concentration of methane in air be less than the lower explosive limit for methane (i.e., less than 5%). Other gases that have been used to promote co-metabolism include propane and butane.

(2) Delivery of gaseous nitrous oxide or triethyl phosphate into groundwater are examples of using of gases other than air with in-situ sparging technology. Nitrous oxide and triethyl phosphate may be added to the air supply of an IAS system to provide nitrogen and phosphate, respectively, to promote biodegradation in saturated soils in which biological activity is naturally limited by the amount of available nitrogen and phosphate (Hazen et al. 1994).

c. Buildings or Enclosures. All air supply equipment should be installed in an enclosure to protect the system from the weather. It could be a roof or shed, provided NEMA 4 enclosures are specified for controls and motors. Judgment must be used to account for the climate of the site. As previously discussed, significant heat is generated from the compression of air, and proper building design should include ventilation that allows for cooling during the warmer months and heat containment during the colder months. This proper ventilation may eliminate the need for additional winterization measures inside the enclosure.

5-9. Design Documents.

a. Specifications. If a typical package of specifications and plans are to be prepared, a number of guide specifications are available for use. Content of the packages depends on the acquisition strategy, customer requirements, and regulator requirements. USACE-CEGS Guide Specifications for Military Construction, which are typically included or can be modified for SVE/BV design, are listed beneath each design component. A potential specification section shown ending in “XXX” is one for which a CEGS does not currently exist but which is under development or should be developed based on the project requirements. The designer should

always check the Unified Facilities Guide Specifications (UFGS) web site* for the most recent versions of all guide specifications and the addition of new ones. For a traditional detailed design, the following sections may be appropriate:

(1) General Clauses and Performance Requirements.

UFGS 02 62 16 Commissioning and Demonstration for Soil Vapor Extraction (SVE) Systems. (This specification can be modified as appropriate for IAS).

UFGS 02 01 50 Operation, Maintenance, and Process Monitoring for Soil Vapor Extraction (SVE) Systems (This specification can be modified as appropriate for IAS)

(2) Site Work.

UFGS 33 20 00 Water Wells (Water Well Specification can be modified for SVE/BV wells).

UFGS 33 24 00.00 20 Extraction and Monitoring Wells.

(3) Treatment Web Site Specifications.

UFGS 23 09 33.00 Instrumentation and Control

UFGS 31 21 00 Piping; Off-Gas

UFGS 43 11 00 Fans/Blowers/Pumps; Off-Gas

b. Drawings. The following drawings would typically be made available for a design package for IAS:

- (1) Site location.
- (2) Project plan with well locations.
- (3) Piping profiles.
- (4) Well construction details.
- (5) Process and Instrumentation Diagram.
- (6) Piping and equipment layout.
- (7) Piping sections.
- (8) Power plan.
- (9) Power/control plans.
- (10) Electrical details.

* <http://www.ccb.org/docs/ufgshome/UFGSToc.htm>

(11) Lighting, power, and one-line electrical diagrams. Areas with NFPA hazard classifications that require upgraded or special electrical components should be shown on the drawings.

c. Performance Specifications. If performance-based contracting is chosen for acquiring IAS services, the performance specification may simply require achieving remediation goals within some period, or may require that the IAS system be designed and implemented so as to achieve the following.

(1) A certain air saturation for a certain period of time in a certain treatment volume, including specific means to measure attainment of this.

(2) No adverse migration of contaminant vapors to the surface, utility corridors, including specific locations and concentration or flux limits.

(3) No unanticipated plume migration because of IAS implementation, including specific monitoring locations and limits on changes in concentrations at these locations.

(4) Appropriate associated SVE system operation and treatment of vapors, including required vacuum conditions or flow rates and treatment requirements for off-gas.

CHAPTER 6

System Construction, Operation, and Maintenance

6-1. Introduction. This chapter addresses IAS construction, operations, and maintenance issues. Operations and maintenance for an IAS system fall into two primary categories: remediation progress monitoring and mechanical system maintenance.

6-2. Construction Oversight.

a. The construction of an air sparging system consists of well installation, piping and wiring installation, and placement of the compressors or blowers and accessories. The construction of an air sparging system is comparable to the installation of a soil vapor extraction system. EP 415-1-261 (Volume 5, Chapter 6) contains specific information on construction of soil vapor extraction systems that can be applied directly to oversight of installation of various components of air sparging systems. In particular, the guidance contained in that chapter is applicable to piping installation and above-ground equipment installation.

b. Refer to EP 415-1-261 (Volume 4, Chapter 2) for information about the installation of air sparging wells. Unlike Chapter 6 of the same document, this chapter addresses the construction of extraction and monitoring wells below the water table. Notably, well seal placement is a critical aspect of air sparging well construction and should be observed in the field. Without a good well seal, there is a potential for air to “short circuit” to the water table along the casing.

6-3. Operation and Maintenance Strategy.

a. The primary considerations in preparing an operation and maintenance plan include the following.

- (1) Achieving remediation success as expeditiously as possible.
- (2) Preventing further environmental impacts via waste streams or contaminant mobilization.
- (3) Maximizing the lifetime of the IAS mechanical system.
- (4) Collecting sufficient data to support these considerations.
- (5) Minimizing costs to achieve these considerations.

b. The designs of a majority of IAS systems are based on a limited amount of site-specific information. Additionally, there is a range of typical system operating behaviors during the life span of a project. Therefore, it is important that flexible operational guidelines be incorporated into site-specific procedures developed to ensure optimum IAS system performance. It is also desirable to frequently consider whether the IAS system is meeting the remediation objectives for the site. Often, installation and operation of the system provides additional insight into the nature and extent of contamination at the site, the conceptual site model, and the very parameters

and assumptions that are the basis of the system design. By monitoring the behavior of the system (e.g., individual well injection pressures and air flow rates), post-construction design adjustments can be made to “tailor” the system to the site. Often, additional IAS wells and headers will be necessary to achieve the remediation goals. For pulsed IAS systems, the duration and frequency of airflow pulses to some or all of the IAS wells may be different from those indicated during pilot testing. Therefore, installing the system in phases, and frequently evaluating optimization of the system can allow the IAS system to better achieve its remediation objectives.

c. Proper operation of an IAS system requires on-going monitoring and system adjustments. If the system is not operated properly, the groundwater plume may migrate off-site. Though sparging in the heart of a contaminated plume is very unlikely to significantly spread the contamination, spreading is possible if sparging is implemented improperly near the leading edge of the plume. This is caused by reductions in aquifer transmissivity and resultant changes in flow paths as a result of creating air-filled porosity in the aquifer. Water levels and contaminant concentrations should be monitored around the plume to potentially identify this phenomenon. Although air emissions from some IAS/SVE systems can exceed those from SVE operating without IAS, in other cases IAS systems may dilute vapor being collected by an SVE system. This may happen because, while concentrations in the groundwater may be above standards, the groundwater may contain much less contaminant mass than the overlying vadose zone. Emissions should be estimated, with the system operator procuring necessary permits or installing emission controls as required. An alternative that may minimize the need for permitting or controls is cycling the IAS operation, as will be discussed in [paragraph 6-6b](#).

6-4. Operation and Maintenance Guidance—Below Grade Components. Subsurface IAS components, as previously discussed, consist of injection and extraction wells and data acquisition probes, which may include monitoring wells, various detectors, and soil gas monitoring points. Minimal maintenance techniques are available for most of these components, short of removal and reinstallation.

a. Injection Wells.

(1) Siltation of injection wells can be a major problem, particularly for pulsed IAS systems. Siltation occurs when airflow and pressure applied to an injection well ceases, and silt particles are mobilized by the inrush of water as the backpressure within the aquifer is “relieved” by flow towards the now lower-pressure well. This effect is particularly pronounced for wells that do not have check valves to dampen the pressure release through the well. However, IAS systems that are pulsed frequently (e.g., four or more times per day) can cause significant migration of silt into IAS wells. Siltation can have a significant effect on the performance of the IAS system. As wells silt-up, the resistance to airflow increases and, therefore, the necessary injection air pressure increases. Different wells will change at different rates, causing injection wells to become “out of balance.” In this way, systems that initially have reasonably similar airflow to each well on an IAS manifold can deteriorate to having most or all of the flow going to several or one “preferred” wells. In the extreme, siltation may result in too much resistance for any airflow into the formation. This phenomenon emphasizes the importance of good well development to re-

move silts and fine particles around the well when installed, and periodic redevelopment of IAS wells.

(2) A consideration for IAS should be the potential for well screen and aquifer fouling via precipitation of metals (primarily iron) or microbial growth. Although fouling does not appear to be a major problem, its potential is not clearly established, and in part is a function of the redox potential of the injectant, aquifer alkalinity, and the type and abundance of organic complexing compounds. The reader is referred to other USACE guidance on dealing with well fouling. Screen fouling has been addressed via physical agitation, and chemical and thermal treatments. Mineral deposits on well screens can be removed using low pH solutions, such as hydrochloric or sulfuric acid. Iron bacteria can be removed by introducing bacteriacides (e.g., chlorine dioxide), followed by low pH treatment after the chlorine is removed from the well. Recommended procedures for the maintenance of wells are detailed in EP 1110-1-27.

(a) High-temperature pasteurization has also been used to control iron bacteria in groundwater. The thermal limitations of well completion materials should be considered if high-temperature pasteurization is employed. Special considerations must be used for applying these techniques to IAS, as the fluid and flow directions are opposite those of supply wells, and fouling will occur on the substrate side of the screen, making foulant removal difficult. Oxidants injected to remove fouling in the wells may cause fouling in the aquifer. Additionally, contaminant mobilization and killing of contaminant degraders are concerns. In some cases well replacement is the most effective approach to deal with well fouling. Placing screened intervals below the zone of contamination may reduce biofouling. SVE wells typically are not subject to screen fouling if they are properly constructed and screened sufficiently above groundwater.

(b) Strategies for minimizing the biofouling associated with the concurrent injection of electron receptors (e.g., oxygen in air) and nutrients (e.g., NO_2) have been reported by Taylor and Jaffe (1991). Although their research focused on in-situ biodegradation, they report that sediments characterized by a high porosity, poor sorting, and a small maximum pore radius are most susceptible to biofouling. By alternatively pulsing the electron donor and acceptor, the propensity for biofouling is reduced. In addition, by increasing the oxygen concentration in the injection water, increasing the discharge rate, and delivering the oxygen through multiple injection wells, bioremediation efficiency was increased without causing excessive biofouling (Taylor and Jaffe 1991).

b. Monitoring Wells and Piezometers. Monitoring wells should be purged prior to sampling, in accordance with standard low-flow groundwater sampling methods (Puls and Barcelona 1996, ASTM D6771). Purging typically entails removing groundwater while monitoring physical and chemical parameters such as pH, temperature, conductivity, turbidity, Eh, and dissolved oxygen to indicate equilibration (equilibration implies that the purged water is representative of the formation groundwater). The use of diffusion bag samplers may be appropriate for monitoring VOCs. Regardless of the sampling method used, the effects of air bubbling up the well on the VOC concentrations must be considered. Purging soil gas monitoring points is not as clearly defined in standard operating procedures, but should be

applied in a similar fashion to the principles that guide groundwater sampling. Soil gas points are typically purged (e.g., three headspace volumes) using a diaphragm pump, which is sometimes also equipped with a moisture knockout vessel. Rotary vane pumps require lubricating oil and are not recommended. Soil gas can then be analyzed by connecting a field measuring instrument (e.g., FID or PID) directly to the monitoring point tubing, or by collecting a soil gas sample in a low gas permeability container, such as a Tedlar[®] bag or Summa[®] canister. Guidance on soil gas sampling is also provided in ASTM D5314-92. Monitoring wells and piezometers typically do not require maintenance for the life of an IAS system operation, other than the replacement or repair of failed surface components such as connectors; however, monitoring wells can silt up and therefore may require redevelopment.

c. Detectors.

(1) Subsurface detectors, such as in-situ oxygen detectors and pressure transducers, require no maintenance short of removal for repair or replacement. The operation of each type of unit is specific to the manufacturer's specifications. Pressure transducers are often connected to surface dataloggers installed in weathertight boxes for extensive or long-term pressure profiling. Over the course of long-term monitoring, membrane-fouling in oxygen detectors should be anticipated, which may require cleaning or replacement every few weeks.

(2) To ensure that vapors produced by IAS do not migrate into nearby buildings, basements, mechanical pits, etc., installing and monitoring of site-specific contaminant sensors or observing differential pressures exterior to such structures versus within them may be advisable.

d. Baseline Measurements. The operator should collect baseline data from a minimum of two distinct time intervals to allow for proper effectiveness evaluations. Prior to start-up of the IAS system, the following baseline measurements should be collected from monitoring locations at the site:

(1) Groundwater levels.

(2) Water quality measurements, including VOC concentrations, dissolved oxygen, temperature, conductivity, pH, and biomonitoring parameters, if desired, such as ammonia nitrogen (NH₃), nitrate nitrogen (NO₃) and carbon dioxide (CO₂).

(3) Soil gas VOCs, O₂, and CO₂ concentrations.

(4) Subsurface pressures (with the SVE system off, if applicable), to assess the magnitude of barometric fluctuations.

(5) Existing SVE system operational parameters, including flow rates and vacuum distribution (if applicable).

(6) SVE system discharge VOC concentrations (if applicable).

6-5. Operation and Maintenance Guidance—Pre-commissioning and Start-up.

a. General.

(1) A start-up workplan should be developed prior to system pre-commissioning and start-up. The workplan should include objectives of the IAS system and the strategy, procedures, and monitoring requirements for start-up and continued operation. The start-up workplan should be a flexible document that will allow for unexpected changes in the field.

(2) If chemical adhesives were used during construction, the VOCs should be purged from the system by opening IAS wellheads and valves and injecting air into the manifold lines with a compressor, and discharging the vapors into a treatment system if necessary. Air purging should last a minimum of 10 minutes and run until results from an OVA or similar device indicate that all VOCs have been purged. This will allow VOCs to discharge into the atmosphere rather than the groundwater when the system begins operation.

(3) The system operator should run the SVE system (if present) until contamination levels have decreased and stabilized. Operating the SVE system before starting up the IAS system has two purposes: i) to establish a capture zone; and ii) to accommodate the elevated VOC concentrations that often accompany initiation of SVE prior to capture of the additional IAS-generated VOCs, the combination of which may otherwise be initially in excess of off-gas treatment capacity. IAS operations should then begin. This will maximize efficiency between the SVE and IAS systems. The SVE system may also control unwanted vapor intrusion into buildings.

b. Start-up Procedure. [Table 6-1](#) provides a checklist for operators prior to beginning start-up services. [Table 6-2](#) outlines procedures for IAS system start-up after completion of manifold air purging. If any well requires more air pressure than the designed operating pressure, or if the delivery pressure of the air supply source is inadequate, system repairs or redesign may be required. Manifold lines can be tested either hydrostatically or with air to evaluate potential leakage.

6-6. IAS System Operation, Maintenance and Monitoring.

a. General.

(1) Increases in air injection flow rates will increase the rate of remediation at most sites up to a point of diminishing returns. Therefore, it may not be cost-effective to operate the IAS system at the maximum flow rate, because the presence of diffusion limitations will affect the efficiency of an IAS system. As previously discussed, the five main factors limiting the rate of air injection are soil matrix considerations, IAS mechanical supply source limitations, SVE equipment limitations, biological (in-situ bioremediation) limitations and preferential air migration. Based on limitations present at specific sites, two separate operational approaches can be used and are called “continuous” and “pulsed.” Whichever operating strategy is selected, on-going system monitoring is required to ensure efficient operations. The following paragraphs present

checklists for IAS system monitoring. Likewise, the system operator should refer to EM 1110-1-4001 for a similar checklist for the SVE system, if used. These checklists should be completed at appropriate time intervals but at least weekly.

(2) Groundwater monitoring during IAS operation provides data necessary to assess the performance of the system. A typical IAS system is monitored for some or all of the following performance parameters.

- (a) Dissolved oxygen (measured via low-flow pumping and a flow-through cell or a down-hole probe).
- (b) Air saturation in the treatment area (measured via neutron access probes, ERT or TDR)
- (c) Soil gas chemical parameters (i.e., VOCs or tracer gas, monitor for vapor intrusion).
- (d) Vacuum distribution in the unsaturated zone (if an SVE system is in operation).
- (e) Groundwater elevations in monitoring wells.
- (f) Pressure distribution in the saturated zone.
- (g) Dissolved contaminants of concern.
- (h) Non-specific groundwater chemistry parameters (e.g., redox potential, BOD, and COD).

**Table 6-1
Suggested Pre-commissioning Checklist**

Checklist Item	N/A	MR	AN	Recommended Action	Responsible (Initials)	Target Complete Date	Comments
SUBSURFACE							
IAS/SVE Wells							
Soil physical and chemical characteristics established							
IAS wells/trenches installed per specification (e.g., screen length, size, diameter, depth, filter pack, grout, seal, riser)							
<i>SVE wells/trenches installed per specification (e.g., screen length, size, diameter, depth, filter pack, grout, seal, riser)¹</i>							
IAS wells purged/cleaned/developed							
Monitoring locations established (e.g., neutron access tubes, ERT boreholes, groundwater monitoring wells, piezometers, and soil gas probes)							
IAS well and monitoring locations surveyed and located on layout plan							
<i>SVE well and monitoring locations surveyed and located on layout plan</i>							
Groundwater access ports installed at each IAS well							
<i>SVE sample ports installed at each well</i>							
IAS airflow control provided at each well head							
<i>SVE airflow control provided at each well head</i>							
Baseline monitoring data collected (e.g., dissolved oxygen, Eh, VOCs)							

**Table 6-1
Suggested Pre-commissioning Checklist (Continued)**

Checklist Item	N/A	MR	AN	Recommended Action	Responsible (Initials)	Target Complete Date	Comments
IAS/SVE Piping							
IAS underground piping to pumps installed per specifications (e.g., size, material type, location, depth, etc.)							
<i>SVE underground piping to pumps installed per specifications (e.g., size, material type, location, depth, etc.)</i>							
Piping insulation/heat tape installed							
Piping flushed/cleaned/pressure tested							
Subsurface as-built equipment schematic provided							
SURFACE							
IAS/SVE Mechanical/Civil							
IAS surface equipment schematic shown (including pressure tanks and compressor)							
<i>SVE surface equipment schematic shown (including blower)</i>							
IAS foundations complete							
<i>SVE foundations complete</i>							
IAS compressor provided and installed per specifications							
<i>SVE blower provided and installed per specifications</i>							
<i>SVE sample ports installed upstream and downstream of blower</i>							
IAS compressor(s) grouted in place							
<i>SVE blower(s) grouted in place</i>							
IAS vibration dampers installed							
<i>SVE vibration dampers installed</i>							
IAS coupling alignment/level to specifications							

**Table 6-1
Suggested Pre-commissioning Checklist (Continued)**

Checklist Item	N/A	MR	AN	Recommended Action	Responsible (Initials)	Target Complete Date	Comments
<i>SVE coupling alignment/level to specifications</i>							
IAS compressor/pipe connections installed/tested							
<i>SVE blower/pipe connections installed/tested</i>							
IAS compressor and seal integrity verified							
<i>SVE blower and seal integrity verified</i>							
Silencers installed before and/or after IAS compressor							
<i>Silencers installed before and/or after SVE blower</i>							
<i>SVE air/water separator provided</i>							
IAS air filtered for oil and particulates							
IAS piping layout provided (as practical and economical)							
<i>SVE offgas treatment installed and functional (if needed)</i>							
Auxiliary fuel operational (if needed)							
Aftercooler system functional (if needed)							
IAS/SVE Electrical							
System grounding installed/checked							
Enclosure lighting/HVAC functional							
Pump rotation verified							
Disconnects in sight of units being controlled							
Power connected to monitoring instruments							

**Table 6-1
Suggested Pre-commissioning Checklist (Continued)**

Checklist Item	N/A	MR	AN	Recommended Action	Responsible (Initials)	Target Complete Date	Comments
Instrument/Controls							
Valves (including air bleed, dilution, and check valves) installed and operation verified							
Temperature, pressure and flow gauges installed in piping upstream (if necessary) and downstream of compressor/blower							
Gauges calibrated, tested, and readings in range							
Control/alarms and interlocks functional							
Notes: ¹ Italicized text identify components associated with SVE systems. N/A Indicates not applicable MR Meets requirements AN Action needed							

Table 6-2
IAS System Start-up Procedures¹

1	Turn on the air source, regulate from a lower pressure to the necessary pressure to attain the design air flow rate for the chosen well group or entire system (as appropriate). DO NOT EXCEED THE MAXIMUM RECOMMENDED AIR PRESSURE. Measure SVE system emissions, if applicable, with appropriate field instruments to verify permit limits are not exceeded.
2	Balance the flow to each well (through adjustment of appropriate valves) as each well may behave differently. If solenoid valves are not used, the operator should use pressure gauges and flow meters to measure and balance air flows.
3	Develop a flow vs. pressure (F/P) curve for each well. The generated F/P curve (which is dependent on water table position) allows determination of well flow rate based upon wellhead pressure measurements. This approach reduces the effort required during routine site measurements.
4	Verify the air compressor and manifold line pressure and total injection flow rate, following the balancing of the wells. Although the agreement between sum of individual well flows and total flow measurement will be approximate, any significant deficiencies will be apparent at this time. A quick check to determine an agreement between total air compressor flow and the cumulative flow as measured at each of the wells is advised.
5	Sample the SVE system inlet, if present, and exhaust streams with an OVM or other appropriate field instrument and analyze over the entire start-up period.
6	Check for bubbling in monitoring wells and piezometers at the site. If bubbling is observed, operators should install air-tight caps on these wells. If these wells are uncapped, fugitive VOC emissions can result. Wells screened across the water table (if present) may act as conduits for air flow. Packing off the entire screened interval may reduce, but will not eliminate such bypassing, as air may still travel through the filter pack. Decommissioning such wells may be necessary.
7	Record periodic groundwater table measurements to document the site-specific impacts on the groundwater mounding/mixing.
8	Measure total pressure and flow measurements after the system stabilizes and measure the pressure or vacuum at gas probes and water table wells to evaluate the site for subsurface air pressure/vacuum.
9	If any positive subsurface air pressure readings or high levels of vapor phase contaminants, or both, are measured in vadose zone monitoring points adjacent to buildings or other structures that may accumulate potentially hazardous vapors, system operators should immediately re-evaluate the operational parameters of the sparging system. DISCONTINUE OPERATION OF THE AIR SPARGING SYSTEM IF CONDITIONS ARE DEEMED UNSAFE.
10	Repeat the previous steps for each of the IAS well groups, as appropriate.

¹ Derived in part from Marley and Bruell (1995).

b. System Operating Strategies.

(1) When operating IAS systems, two prevalent limitations for system effectiveness can occur: i) kinetics of mass transfer at the air/water interface, or ii) the rate of mass transfer of the contaminant from the water phase to the air/water interface. Marley and Bruell (1995) hypothesized that pulsed operation can be used to assist with agitation and mixing of the water as air channels form and collapse during each cycle. Johnson (1994), however, suggests that while pulsed injection may increase the air/water contact, the overall effects on groundwater mixing may be modest. While these mechanics may be debatable, pulsed operation should be considered the default IAS strategy, rather than continuous operation, for all but the most uniformly permeable sites (i.e., coarse sand and gravel aquifers).

(2) Pulsed injection involves a different rationale and approach. Some investigators and practitioners have cycled sparge systems by varying the injection pressures or by simply turning the system on and off, known as pulsing (Marley et al. 1992a, Johnson et al. 1993). The con-

ceptual model suggests that air channels will form in pathways with the largest pore diameters (Ahlfeld et al. 1994). As long as the pore geometry remains the same from one pulse cycle to the next, air pathways should remain fairly constant (assuming that secondary fractures do not develop due to over-pressurization). McKay and Acomb (1996) found that air distribution profiles measured with a neutron probe were repeatable with each cycle of operation. However, careful monitoring of testing in a sand tank by Johnson et al. (1999) indicated that some fluctuations in airflow pathways would explain fluctuations in mass removal rates during IAS. During these same experiments, pulsed IAS operation resulted in substantially greater (by a factor of 2) VOC removal than during continuous operation, even in coarse sand.

(3) Even if the presence of residual air saturation following a cycle initially blocks the displacement of water during the next cycle, airflow evidently becomes reconsolidated within the same preferred channels each time, at least insofar as where the airflow channels terminate at the ground surface (Leeson et al. 1995). Pulsed operation intermittently reproduces the expansion phase (Figure 4-5A,B), during which air-filled saturation values appear to be maximized over the largest subsurface volume (McKay and Acomb 1996). Therefore, pulsed operation may produce a somewhat larger ZOI than continuous operation.

(4) It appears (paragraph 2-7a) that pulsing promotes: i) groundwater mixing in the vicinity of air channel locations, and ii) mass transfer of air into the water phase. Pulsed operation increases the air-to-water contact area, thus maximizing gas-liquid mass transfer within the saturated soil. Groundwater mixing is established as air channels form and collapse during a given cycle. This process reduces the degree to which diffusion governs mass transfer, resulting in an increase in mass transfer of hydrocarbons from water to the air phase (Wisconsin DNR 1993). Figure 6-1 provides an example of enhanced mass removal resulting from pulsed sparging (Clayton et al. 1995). The transient mounding period is the recommended design parameter for the duration and frequency of pulsing. Cycling from one sparge well to another using the same compressor also provides a cost savings because of smaller gas compressor requirements and reduced energy costs (Marley et al. 1994). Pulsing can also be an economical and desirable approach for use during biosparging applications.

(5) Balancing of flows to individual IAS wells is often critical to the success of the IAS system. IAS systems will tend to migrate to preferential flow to a single or a few wells that have less resistance to flow than the rest of the well manifolded to a pressure header. This migration can be more pronounced for pulsed systems in which flow is started and stopped to the wells frequently. Consequently, it is important to periodically monitor and adjust the airflow to individual wells to ensure that the airflow to each well connected to a header is balanced. Periodic airflow balancing will minimize periods of “no-flow” to significant portions of the site.

(6) It should be noted that at locations that are well suited to IAS (i.e., lack of confining layers) pulsing is not expected to cause groundwater to migrate in new directions. Consideration must still be given to what, if anything, can cause contaminant migration and how to avoid it.

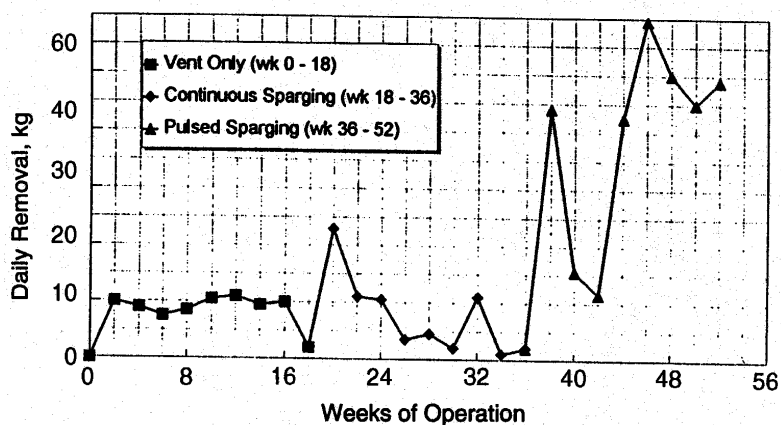

Figure 6-1. Mass removal rates were greatly improved by pulsed sparging relative to earlier periods when venting only and continuous sparging had been implemented (after Clayton et al. 1995).

c. Biological Monitoring.

(1) General. The progress of a biosparging remediation can be assessed through a variety of means, including biological monitoring. Microbial counts, for example, are likely to rise as remediation proceeds (Table 3-4), because IAS may stimulate the growth of microbes. To monitor microbial activity, heterotrophs as well as specific degraders are often enumerated. Beyond a point, there may be little benefit in attempting to increase biomass because increased biomass may retard flow through the subsurface. The population density of the specific degraders is often limited by factors such as mass transfer of electron acceptors (e.g., oxygen), electron donors (e.g., hydrocarbon), and nutrients (e.g., nitrogen and phosphorus). Rates of desorption and dissolution of hydrocarbons may also limit microbial activity. Biological monitoring may contribute to understanding the limiting factors and aid in deciding whether to pursue actions such as nutrient addition.

(2) Push-Pull Tracer Test. Amerson et al. (2001) developed a diagnostic push-pull multi-tracer test to evaluate the relative rates of volatilization and biodegradation during operation of an IAS system. A tracer solution, consisting of a visible dye; a conservative tracer; a biodegradable, non-volatile tracer; and a non-biodegradable, volatile tracer, is injected into monitoring points within the treatment area and at a background location. After waiting a short time (e.g., a day) for volatilization and biodegradation of the non-conservative tracers to occur, the tracer solution is withdrawn by pumping a volume sufficient to recover the bulk of the tracer solution. During their tests, Amerson et al. (2001) were able to measure the relative removal of each of the non-conservative tracers. Therefore, the relative rates of biodegradation and volatilization could be calculated for each test location to evaluate the effectiveness of IAS system operations at a particular location. Because this test can be done rapidly and without reference to aquifer baseline conditions, it can be used to evaluate a variety of system operational parameters. At the time of publication (2001), the push-pull test was not fully developed, and tracer selection was not standardized.

d. System Operating and Monitoring Procedures. A properly operated and monitored system is required to achieve project objectives. The following chapters provide details to assist an operator with the proper operation of an IAS system. The first few months of system operation are critical to ensure that accidental spreading of VOCs does not occur and to measure system performance.

(1) Equipment. As shown on [Tables 6-3a, 6-3b, and 6-3c](#), specific measurements must be made to develop an understanding of system operations, trends, and effectiveness. These tables have been separated into system measurements, general inspection, and system maintenance. All equipment must be operated in accordance with manufacturer's recommendations. Responsible individuals should discuss any deviations noted during O&M operations and temporarily shut-down systems as warranted.

(a) Pressure Measurement. Pressure readings must be collected and can be measured with manometers, pressure gauges, or pressure transducers. For the critical collection of data on the compressor's discharge pressure, it is suggested that electronic pressure transducers, in conjunction with an automatic data logger, be used to record the data at regular frequent intervals. Over time, the data logger provides a cost-effective alternative to taking manual readings, especially at remote sites. Logged data can be accessed remotely via computer modem. However, the data should be verified periodically with manual readings.

(b) Air Velocity Measurement and Flow Rate Calculation. Air flow rates must be measured at each IAS well. Air intake rates should also be measured at the ambient air inlet of the compressor. Measuring the flow on the intake side of the compressor will provide a value requiring no correction for pressure changes and little correction for intake temperature, as would be the case on the discharge of the compressor. Airflow measurements can be made using a variety of flow meters, including rotameters, hot-wire anemometers, and flowmeters based on a differential pressure reading inside the pipe. Such pressure related flowmeters include venturi meters, orifice plates, averaging pitot, and pitot tubes. Pitot tubes, rotameters, and hot-wire anemometers are typically the most appropriate measuring devices. However, the presence of water in an airstream reduces the accuracy of all flowmeters, and can damage hot-wire anemometers. Airflow measurements must be properly evaluated to account for pressure and temperatures effects on air density (see [Appendix C](#))

(c) Injected Air Temperature at each IAS Well. Vapor temperatures should be monitored to enable the conversion of flow rates between measured flow, standard flow, and actual flow, as discussed in [Appendix C](#), and to ensure accurate determination of the efficiency of the IAS. In addition, piping typically used for IAS applications normally has a temperature limit above which the piping may fail.

(d) Water Levels. Water levels should be monitored in the area of around the IAS wells to determine the location of the water table (as it changes) relative to the injection well screen.

Also the degree of mounding that occurs during the onset of air injection (i.e., the expansion phase) should be periodically checked.

(e) Compressor Motor Amperage. Compressor motor amperage should be monitored as a means of determining the load placed on the motor. Excessive amperage may indicate low flow or high pressure, which could lead to overheating. The amperage can usually be measured at the compressor’s control box using a basic ammeter. The data should be compared with the suggested operating range supplied by the blower manufacturer.

Table 6-3a
Example IAS System Operational Checklist Mechanical System Measurements

Inspector name:		Date:	
------------------------	--	--------------	--

Item	Time Checked	Typical Values*	Initial Reading	Reading After Any Adjustments
Compressor/Blower Discharge Pressure		8 psi		
Compressor/Blower Discharge Flow @ Pressure Above		100 cfm		
Sparge Blower Discharge Temp.		240°F		
Bearing Oil Temperature		200°F		
Bearing Oil Pressure		20 psi		
Interval Operating Hours		—		—
Motor Amps		8		
Oil Level		—		
Aftercooler Inlet Pressure		7 psi		
Aftercooler Inlet Temperature		180°F		
Aftercooler Outlet Pressure		6 psi		
Aftercooler Outlet Temperature		120°F		
Ambient Air Temperature (outside/inside shed)		—		—
IAS-1 ¹ Wellhead Pressure		5.5 psi		
IAS-1 ¹ Wellhead Air Flow		6 cfm		
IAS-2 ¹ Wellhead Pressure		7.4 psi		
IAS-2 ¹ Wellhead Air Flow		2 cfm		

Notes: 1. Each other IAS well should be listed individually.
2. Operator should operate valves and controls at least once each month.

* Values shown for example only, column to be filled in according to actual typical measurements

**Table 6-3b
Example IAS System Checklist General Inspections**

Inspector name:	
Date:	

Item	Time Checked	Normal Situation*	Observations
Shed/trailer lock		locked	
Mechanical Equipment		all IAS blowers operating	
Equipment Housing		no rattling	
System By-pass Valve		closed	
System Flow Valves		0.5 open	
Electrical Controls		all go	
IAS Well Heads		all intact	
Notes: 1. Operator should operate valves and controls at least once each month.			

* Situations shown for example only, column to be filled in according to operational plans

**Table 6-3c
Example IAS System Checklist Equipment Maintenance**

Inspector name:	
Date:	

ITEM	TIME CHECKED	MAINTENANCE PERFORMED	MINIMUM SCHEDULE*
Oil Change			biannually
Oil Filter Change			quarterly
Air Filter Change			monthly or diff. pressure > 15 " water
Activated Carbon Drums			quarterly or diff. pressure > 5 psi
Moisture Separator Tank			quarterly
Blower Lubrication			every 1000 hrs

Comments/observations:

Notes: 1. Operator should operate valves and controls at least once each month

* Schedules shown for example only, minimum maintenance must be set according to equipment specifications.

(2) Monitoring Frequency. The frequency of monitoring of an IAS–bosparging system is specific to the site and remediation strategy. Before implementing an IAS–biosparging system, it is important for the design team to establish data quality objectives that are appropriate for monitoring the progress of the system relative to site-specific target cleanup levels. Once the system is installed, baseline data may be collected and subsequently future data needs are identified. A Quality Assurance Project Plan should be prepared that establishes both monitoring methods and frequency.

(3) System Operating Modifications. As previously stated, initial operations and monitoring are critical. It is important to detect, quantify, and correct problems (as necessary) that may have arisen initially. After data collection, detailed emphasis must be placed on interpretation of results and appropriate actions taken for system optimization. Monthly comparisons of results versus project goals must be obtained and tracked. Large-scale and long-term IAS systems should be independently evaluated periodically to assure effectiveness and reduce operating costs. The USACE Remediation System Evaluation (RSE) process is intended to provide a framework for such evaluations. General guidance for conducting RSEs and specific checklists

for evaluating IAS systems and related equipment (e.g., blowers, piping, controls) and remediation monitoring are available.*

(4) Recordkeeping. A formal data management system is recommended. Information collected, as outlined herein, must be tracked. Collected information must reference date, time, and location for all data, with appropriate comments noted.

(5) Operator Training. Formal operator training is needed to adequately prepare site operators to safely and effectively operate and maintain IAS systems. Training should include both hands-on and classroom training.

(6) Troubleshooting. There are several mechanical components for an IAS system that are subject to operating problems. These include filters, pumps, valves, control systems, and mechanical units. [Table 6-4](#) has been developed to use as a guide for operating strategy and to evaluate potential solutions. This table assumes the use of an SVE system in conjunction with the IAS system.

(7) As-built and O&M Plans. As-built and O&M plans should be developed upon system completion to use for long-term monitoring and evaluating effectiveness. An as-built plan should include the following at a minimum:

- (a) Boring logs.
- (b) Well construction diagrams.
- (c) Locations of IAS wells.
- (d) Piping, manifold, valve, instrumentation, equipment, and sampling locations.
- (e) Process schematic as actually configured with all manual–automatic controls explained (including controller logic).
- (f) Contaminant source and extent locations, if applicable.
- (g) Site information including scale, north arrow, legend, title block, and groundwater flow direction.

(8) O&M Manual. The system O&M manual will constitute a very important document for the project. It must be written in an understandable format and contain a description of all activities (including specific checklists) to be performed, along with detailed contingency plans and training requirements. [Table 6-5](#) is a general outline of topics to be covered in an IAS O&M manual.

* <http://www.environmental.usace.army.mil/library/guide/rsechk/rsechk.html>.

Table 6-4
IAS System Operation Strategy and Troubleshooting Guide

Problems	Considerations	Potential Solutions
The zone of influence is insufficient or not as predicted.	The soil may be less permeable in some locations or there may be preferential flow.	Further subsurface investigation. Readjust flows. Additional wells. Higher IAS well density. Check wells for clogging. Check for short circuiting.
Groundwater levels are spatially inconsistent.	There may be preferential flow or heterogeneities.	Further subsurface investigation. Additional wells. Seal preferential pathways.
Increasingly high injection pressures.	Potential well fouling.	Clean wells. Purge manifold lines.
The VOC concentrations have been reduced in some but not all wells.	Treatment may be completed in some areas of the site.	Reduce flows to some wells. Take some wells off-line. Check for ongoing sources of contamination. Check for rebound.
The VOC concentrations remain consistently high despite high mass removal rates.	Undiscovered groundwater contamination of free-phase product or DNAPL.	Further investigation. Product recovery. Shift approach.
Low concentrations of VOCs are extracted during operation, but high concentrations reappear when system is shut off.	Diffusion limitations, flow short-circuiting due to preferential flow, airflow rates higher than necessary.	Pulse sparging. Hot gas injection. Excavation of "hot spots" and ex-situ soil treatment.
A decline in concentration levels has made thermal/catalytic oxidation economically infeasible.	"Tailing" of the concentration versus time curve is a common occurrence.	Evaluate uncontrolled air emission. Activated carbon. Biofilters. Use other technologies to speed up removal. Possibly reduce airflow rates.
Poor SVE performance following large rain events.	The system is sensitive to the effects of soil moisture on air permeability and aeration.	Cap site. Dual recovery. Shut off system following major rain events.
Unexpectedly high vapor concentrations at or near explosive levels.	Free-phase product; accumulation of methane or other VOCs.	Dilute SVE intake air. Alter system to be explosion-proof. Check for unknown sources of contamination.

Table 6-5
Typical IAS O&M Manual

<p>I. Introduction</p> <ul style="list-style-type: none"> A. Purpose/Background B. Cleanup Goals C. Discharge Limits D. Description of Facilities E. Project Organization 	<p>V. Sampling, Analysis and Reporting Documentation</p> <ul style="list-style-type: none"> A. Sampling and Analysis Schedule B. Reporting C. Quality Assurance
<p>II. Description of System Components</p> <ul style="list-style-type: none"> A. Well Configuration and Construction Detail B. System Piping and Instrumentation C. Air Sparging Compressor/Blower D. Ancillary Equipment E. Controls 	<p>VI. Record Keeping, Data Management and Reporting</p> <ul style="list-style-type: none"> A. Record Keeping and Data Management B. Alterations to Remediation System C. Revisions to the O&M Plan D. QA/QC Revisions
<p>III. System Operation</p> <ul style="list-style-type: none"> A. Start-up B. Routine Operating Procedures C. Troubleshooting 	<p>VII. Contingency Plan</p> <ul style="list-style-type: none"> A. Mechanical Contingencies B. System Modifications C. Criteria for Triggering Corrective Action
<p>IV. System Maintenance</p> <ul style="list-style-type: none"> A. Weekly Inspections B. Routine Maintenance Procedures C. Consumables and Spare Parts Inventory 	<p>VIII. Personnel Training</p> <p>Appendix A - Health and Safety Plan</p> <p>Appendix B - Standard Operating Procedures</p> <ul style="list-style-type: none"> • Air Sampling • Water Sampling • Water Level Measurement

CHAPTER 7

System Shutdown and Confirmation of Cleanup

7-1. Introduction.

a. System shutdown should be considered when process monitoring shows that either the remediation objectives have been met, or the system is no longer be cost-effective (i.e., the system has reached an asymptotic level of mass removal). System shutdown involves two primary components: i) closure sampling and analysis, which may need to be conducted over an extended period of time, and ii) IAS mechanical system shutdown, disassembly, and decommissioning. The closure sampling program should be conducted over a period of time to evaluate contaminant concentration rebounding, particularly at sites where NAPL was present. Post-closure monitoring is also advisable in many instances, as when NAPL remains after closure.

b. Shutdowns for mechanical or maintenance reasons are not considered here. They almost exclusively depend on the individual system components selected, and will accordingly vary in duration and severity. However, every system will require some shutdown time for maintenance and lubrication. The procedures for conducting these shutdowns will be specified in the O&M manual for the apparatus used.

7-2. Shutdown Strategy.

a. The shutdown strategy, including cleanup levels, sample schedules and methods, and a closure decision matrix, should be planned prior to starting up an IAS system. [Figure 7-1](#) is a generic closure matrix for evaluating data, incorporating a typical shutdown strategy. This strategy should be incorporated into the Work Plan, and should be approved or agreed to by the appropriate regulatory entities. The shutdown strategy may require revision, such as identifying different or additional sample collection locations, if the spatial distribution of contaminants in the soil or groundwater changes over the duration of the IAS system operation.

b. System shutdown will be guided by the regulatory standards applicable to the site contamination. These site specific standards typically include state or Federal Maximum Contaminant Levels (MCLs), although in some cases, alternate cleanup goals can be negotiated based on specific potential local receptors and contaminant mobility. Risk-based target cleanup concentrations can be developed based on an understanding of the initial contaminant mass distribution, groundwater hydrology, and actual or potential groundwater use. Risk-based target concentrations are generally developed to prevent unacceptable concentrations at a defined compliance point. Even at sites where IAS cannot uniformly reduce concentrations below MCLs, IAS can usually substantially reduce contaminant source mass and the resulting contaminant flux out of the treated zone. The goal of reducing contaminant flux is to eliminate unacceptable exposure conditions at potential receptors. Typical parameters used to design IAS systems and support alternate cleanup goals include soil organic carbon content and hydraulic conductivity. An

understanding of contaminant distribution, fate, and transport can guide and minimize additional data acquisition requirements.

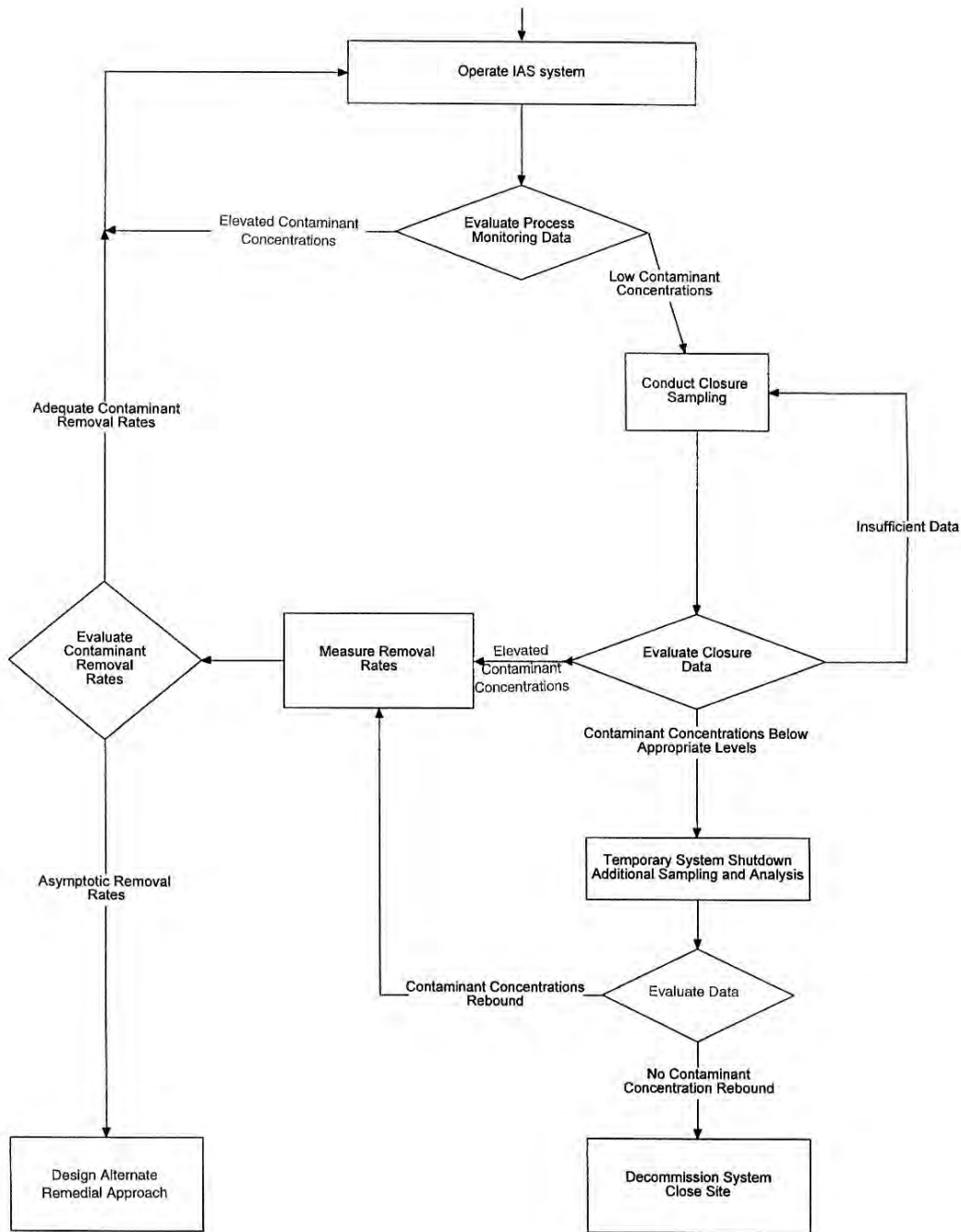

Figure 7-1. Closure data evaluation decision matrix.

c. In most cases, actual sampling and laboratory analysis of the contaminated matrix (e.g., groundwater) is the only acceptable means of achieving closure approval. In some instances, secondary indicators such as exhaust gas and soil gas VOC concentrations, groundwater physical and (non-target) chemical parameters, and oxygen consumption rates have been proposed as

acceptable indicators of contaminant concentrations. These secondary indicators, which typically are included in IAS process monitoring, determine the timing of matrix sampling to demonstrate achievement of regulatory objectives. Confirmational sampling should be conducted in accordance with standard SW 846 soil and groundwater sampling and analysis methods, as summarized in the work plan (USEPA 1986).

d. Groundwater monitoring wells generally present an overly optimistic picture of VOC and DO concentrations during, and for a while following, IAS. This is because of the tendency of sparged air to flow preferentially through a well's filter pack and into the well itself ([paragraph 3-3a\(5\)](#)). Thus, concentrations in groundwater monitoring wells may not represent the groundwater in the formation. It is, therefore, very important that sufficient time be allowed to elapse between IAS system shutdown and confirmation monitoring using conventional groundwater monitoring wells. Johnson et al. (1995) recommend a waiting period of greater than 1 month at wells that have been directly affected by IAS. To adequately evaluate the success of IAS, a minimum of 2 to 3 months should elapse between shutdown and confirmation monitoring. The natural flow velocities in the aquifer should be considered in selecting the timing for confirmation sampling. Sites with slow natural flow velocities may require longer times between shutdown and sampling; higher velocities may allow a reduced waiting time.

e. Waiting for a suitable period between shutdown and confirmation monitoring provides an opportunity for groundwater concentrations to “rebound” and thus facilitates more accurate measurement of remediation success. Rebound can be ascribed to one of two processes: i) non-representativeness of conventional monitoring wells within the sparging area (as discussed above); and ii) re-equilibration of groundwater with sorbed or non-aqueous phase contaminants in the treatment zone. Bass and Brown (1996), summarizing their IAS database findings, concluded that “When rebound occurred, it sometimes happened many months after sparge system shutdown.” They reported that some sites “showed only moderate rebound 2 to 4 months following shutdown, but in some source area wells concentrations jumped by another order of magnitude or more within 7.5 to 16 months after shutdown.” In this cited IAS database, rebound was more frequently observed at sites contaminated with petroleum hydrocarbons than with chlorinated solvents (Bass et al. 2000). Rebound is most common at sites that initially appear to contain residual LNAPL or free-product. In some cases, rebound appeared to be related to a rising water table. If some degree of rebound is noted, sampling should be repeated subsequently. Applicable state or Federal closure requirements may dictate the duration and frequency of confirmation sampling.

f. Wisconsin DNR (1995) recommends that, when purging monitoring wells prior to sampling, the purge volume be increased to remove water in and near the filter pack that may have been affected by preferential flow along the well. They suggest that the purge volume required to draw in unaffected (i.e., more representative) groundwater may be considerable. Care must be taken to avoid aerating the well and stripping VOCs from the water in the process of purging it ([paragraph 4-2](#)).

g. If groundwater samples from small-diameter driven probes are acceptable, such probes may be used to procure more representative samples, as they lack a filter pack capable of preferentially conducting airflow and their screen length is very short (Johnson et al. 1995, Wisconsin DNR 1995).

h. There are three possible outcomes from a successful closure sampling and analysis program to be considered in the shutdown strategy. The decisions to be made in each case will depend on the regulatory, cost, and technical constraints under which the system is being operated.

(1) Contaminant concentrations are and remain below applicable standards.

(2) Contaminant concentrations are below applicable standards; however, concentrations rebound following system shutdown.

(3) Contaminant concentrations are above applicable standards, yet the system has reached asymptotic removal rates.

i. Even if contaminant concentrations are above applicable standards, and the system continues to remove contaminant mass, it may still be possible to close the site, based on renegotiation with regulators after a reasonable period of operation. Such a strategy, if deemed acceptable, would employ natural attenuation as a follow-on to IAS.

7-3. Shutdown Guidance.

a. General. The simplest method of planning for shutdown and final sampling is to regularly monitor the site and track the data trends.

(1) There are three groups of parameters that may indicate that the cleanup is nearing an end:

(a) Reduced VOC in the Collection System. A gradual drop in VOC concentrations in the exhaust stream, usually from an SVE system, may indicate that contaminant levels in the soil have been depleted, at least in the ZOI. They may, however, merely indicate that mass transfer has become diffusion-limited.

(b) Reduced CO₂ or Increased O₂ in the Exhaust. Where bioremediation parameters are being tracked in the SVE exhaust stream, a change in these concentrations may indicate that there is little material left to degrade. Periodic in-situ respirometry tests, either in the vadose zone (Hinchee et al. 1992) or in the groundwater ([paragraph 4-3d](#)), may help support this trend.

(c) Reduced VOC or Increased Dissolved Oxygen in Groundwater Samples Collected after the IAS System is Shut Off. These data must be interpreted carefully, taking care to assure that the samples are representative of the concentrations in the formation, as described above. Bio-

degradable compounds will not necessarily be completely degraded, at first, in which case they may act to solubilize additional organic material into the groundwater, with an attendant rise in VOC concentrations. When this concentration subsequently falls, it may signal that the ZOI may have been finally depleted of partial breakdown products, and that bioavailable constituents have, to a practical extent, been removed. Sustained elevated dissolved oxygen in the groundwater (i.e., greater than 1 or 2 mg/L) also indicates substantial removal of the mass of organic contaminants. A decline in the dissolved oxygen toward initial low levels (indicating oxygen uptake by bacteria degrading organic compounds) is another symptom of rebound and may indicate that further treatment is necessary.

(2) When one or more of these conditions appear, it is most useful to reread the criteria for shutdown written into the approved work plan or operating permit. This should provide the guidance necessary for the final confirmation sampling. The criteria should also specify whether or not the system is to be shut off for confirmation sampling, as is usually the case.

(3) Some general guidance for typical systems is provided below, for subsurface and surface equipment. This guidance assumes that the system has attained its remediation targets and final shutdown is required.

b. Shutdown Guidance—Subsurface. ASTM D5299 gives general requirements concerning well decommissioning; however, well decommissioning procedures usually depend on state requirements, and these requirements must be checked prior to beginning decommissioning.

(1) The most typical case requires that the well be pressure-grouted and the surface restored to its previous condition. This usually means that the top 0.6 to 0.9 m (two to three ft) of casing are cut and pulled from the well; the well is bored and a cement/grout mixture is placed down the well using a tremie pipe to fill the bore to the surface. Any curb boxes or other protection for the wellhead are also removed, and the surface is restored to match the surrounding grade and surface finish.

(2) In some cases the casings must be pulled. Even if this is not required, a licensed driller may need to be contracted to decommission the well. The most common method is to mechanically pull the casing from the ground (for shallow wells) or drill out the casing for deeper installations.

c. Shutdown Guidance—Surface Equipment.

(1) The surface equipment is often configured in a package, and so the package is simply moved to storage or to another site. The surface piping and manifolds are removed and usually discarded, using appropriate waste handling practices. Consideration should be given to removing and storing gauges, thermometers, and other measuring equipment, depending on their con-

dition and value. It is particularly important to properly decommission the system pumps and blowers. These units are often built with tight tolerances and can “freeze up” with rust or corrosion. Care should be taken to follow manufacturers’ recommendations for both short downtime periods and extended system shutdowns.

(2) When the piping systems have been disassembled, it is helpful to blind-flange the piping connections to the package equipment, to prevent unnecessary exposure to the surroundings. It is also helpful to store the saved gauges and other measuring equipment with the package unit, so that they can be reused at the next site.

CHAPTER 8

Other Issues

8-1. Introduction. Administrative items that warrant consideration in IAS include legal and regulatory, patent, and safety issues. These three issues are discussed herein. A working knowledge of legal and regulatory requirements associated with constructing and operating IAS systems is critical to ensure compliance with federal, state, and local requirements. Secondly, patents related to IAS have been issued, which may affect the use of certain aspects of IAS. Thirdly, because IAS systems require working with compressed gases and may involve discharging subsurface vapors, strict adherence to health and safety protocols is required.

8-2. Legal and Regulatory Issues.

a. During the design process, it should be determined if there are any Federal, state or local standards, criteria, or requirements, including procedural or permitting requirements, that must be incorporated into the project. Normally, for projects conducted under CERCLA, and for projects on Federal property, permitting or other procedural requirements will not be applicable to work at or near the site; however, the substantive elements of the laws relating to any permits may need to be incorporated into the design. For the construction phase of the work, standard government contract clauses will require the contractor to obtain any construction related permits or approvals that are legally required. The Office of Counsel should be consulted to advise on any applicable requirements if there are questions or in the event of any disputes.

b. Other construction-related requirements include management and disposal of investigation-derived wastes (IDW) generated during construction and implementation. Federal laws and regulations under RCRA, CERCLA, and TSCA may apply, as well as state laws and regulations pertaining to local solid and hazardous waste receiving facilities.

c. Many states require drilling permits for well (and sometimes sample point) installations, and also written authorization or permits for air and groundwater discharge. It is critical that the discharge criteria be thoroughly researched during the conceptual design phase of a pilot- or full-scale IAS system. Specific construction requirements, such as the height of vent wells, may need to be heeded. Additionally, discharge requirements including sampling parameters and frequency must be considered. Treatment with vapor-phase granular activated carbon (GAC) for off-gas or liquid-phase GAC for groundwater, may be required to comply with discharge criteria. Alternately, a modified implementation plan, such as lowering the airflow rate, or shortening the duration of pilot tests, could eliminate the need for treatment. There may be standards, limitations, or coordination requirements arising under the Clean Air Act that may affect the emissions allowed from a system. If the work is conducted on a Federal installation, the local installation environmental coordinator should be consulted to determine if the installation has any sort of permits or limitations regarding air emissions.

d. Proper procedures must be developed or documented for handling potentially hazardous materials required on site during IAS implementation. Materials required on site may include compressed gas cylinders, radioactive sources for neutron logging, and decontamination fluids such as methanol and nitric acid. USDOT shipping laws and regulations may apply for packaging and transport, and USEPA laws and regulations may apply to the management and disposal of spent materials. The site-specific situation must be evaluated to determine what, if any, requirements apply to the handling of materials, especially waste, during and at the completion of the project.

e. In addition to Federal, state, and local laws and regulations, relevant USACE guidance is available. Although USACE has not published specific air sparging guidance prior to this EM, EM-1110-1-4001 provides information covering many relevant topics that also apply to IAS.

8-3. Patent Issues. There are several patents that have been issued relative to technologies discussed in this EM. Readers are advised to consider the ramifications of these patents on their site activities. A first step toward this end is facilitated by a review of the summary of air sparging patents that follows. If closer scrutiny is required, a copy of the patent can be obtained promptly from the U.S. Patent and Trademark Office by mail for a minimal charge by calling (703) 305-4350, or from the U.S. Patent and Trademark Office web site*. Contact Office of Counsel for further guidance on addressing this issue. The following list of patents with associated summary descriptions is not intended to represent a complete patent search. It is organized from the most complex and encompassing patents to the straightforward single process- and media-specific categories that can generally be quickly evaluated. The SVVS[®] patents are discussed first and in considerably more detail, as many air sparging applications will either narrowly miss infringing on the patents or may require appropriate licensing for use of the technology. Note that the validity of any of the described patents has not been determined. The United States has authority to make use of any patented item or process in the course of any project, and cannot be refused use or enjoined from use of any patented item or process. Under the procedures of Title 28 United States Code 1498, a Federal agency may be required to pay reasonable compensation for the use of any patented item or process. This is normally done by negotiation or determination of a reasonable fee to obtain the right to use the patented item or process under a license agreement. Government contract clauses are prescribed for use in various types of contracts that may require the contractor to obtain any applicable licenses, and may in some cases require the contractor to indemnify the government in the event of a claim for compensation from a patent or license holder. The Office of Counsel should be notified in the event of any questions or disputes related to patents.

a. Billings and Associates, Inc. Subsurface Volatilization and Ventilation System (SVVS)[®] (# 5,221,159; # 5,277,518; # 5,472,294). The SVVS[®] process is an integrated, in-situ technology that utilizes the benefits of air sparging, soil vapor extraction, and bioremediation to

* <http://www.uspto.gov>

treat subsurface organic contamination in soil and groundwater. The patents' abstracts define the process.

“At least one injection well is drilled through the vadose zone to a depth below the water table defining the upper boundary of the aquifer. One or more extraction wells are established to a depth above the water table. Oxygenated gas is injected under pressure through the injection well(s) while a vacuum is applied to the extraction well(s). Contaminants are removed from the groundwater aquifer and from the vadose zone by a combination of physical, chemical, and biochemical processes. Additional specifications address simultaneous free product recovery, nutrient addition, and natural microbe fermenting and reintroduction.*”

Recall, we have stipulated: “Air Sparging shall be defined to be the introduction of air, or other gases, in the saturated zone to remove contaminants by volatilization or bioremediation or to immobilize contaminants through chemical changes.” Thus, some of the physical steps for most IAS systems will necessarily be similar or identical to those specified for SVVS[®] implementation. The patents provide additional detail and insights about the SVVS[®] process, as follows:

“This invention is an integrated delivery system to effectuate the advantageous characteristics of, primarily, bioremediation. This is because bioremediation causes 70% to 80% of the remediation success on a hydrocarbon contaminated site. For cost reasons, a delivery system must be capable of injecting air or other vapors capable of supplying oxygen for the enhanced bioremediation as well as nutrients for enhanced bioremediation. The same physical delivery system for injected air is used to gain the advantage of air stripping aspects of remediation. However, injection of air leads to relatively uncontrolled distribution of vapors moving up from below the water table through the vadose zone and possibly to exit points that were unsatisfactory to the populations living above the pollution. Therefore, a vacuum portion of the system controls the distribution of the vapor phase. The purpose is not primarily to remove volatiles by vacuum, but to control the entire vapor movement system containing portions of contamination and biological byproducts...†”

The first SVVS[®] patent infringement case was settled in Federal District Court in 1994 with an Order of Dismissal that stipulated infringement. Several other environmental industry leaders and others have apparently concluded that their methods of employing air sparging do not infringe on SVVS[®] patents. Again, users are advised to consult the Office of Counsel for specific patent guidance. SVVS[®] license information is available from Mr. Jeffery Billings, Environmental Improvement Technologies, Inc., 12415 North 68th Place, Scottsdale, AZ 85254, (602) 596-0426.

b. 21st Century Environmental Remediation Technology Corporation; BioSparge (# 5,246,309). This is a closed-loop, in-situ system of gas injection wells combined with surrounding low flow vapor extraction wells and a mobile surface treatment unit to provide injection, enhanced bioremediation, VOC capture and stripping without gas venting or emissions or groundwater withdrawal. Gas injection can be designed for heated and oxygenated gas to provide oxidation, volatilization, and nutrient addition (if necessary) to enhance bioremediation.

*United States Patents 5,277,518, 5,277,518, 5,472,294 Abstracts.

†United States Patent 5,277,518 page 13.

License information is available from Mr. Robert V. Murton, 21st Century Environmental Remediation Technology Corporation, 6380 South Eastern Ave., Suite # 8, Las Vegas, NV 89119, (702) 798-1857.

c. Department of Energy; Two Sets of Horizontal Wells (# 4,832,122). This is an in-situ system for removing VOCs from a subsurface plume by injecting a fluid through a horizontal well into the saturated zone on one side of the contamination and collecting the fluid together with volatilized contaminants through a horizontal extraction well on the other side of the plume. The fluid may be air or other gas or a gas and liquid mixture. Though this patent includes the use of horizontal wells, it does describe the general concept of air sparging and pre-dates other air-sparging patents. This and other DOE patents may represent a strong basis for conducting air sparging on U.S. Government projects. Again, consult with Office of Counsel.

d. IEG™ Technologies Corporation; UVB (# 5,116,163). The Unterdruck-Verdampfer-Brunnen (UVB) is an in-situ technology to remove VOCs from groundwater through a single well with two hydraulically separated screened intervals installed within a single permeable zone. A blower creates a vacuum that simultaneously draws water into the well at the lower screened portion (to be discharged at the upper screen creating a circulation pattern) and ambient air through an inner pipe discharged at the base of the wellbore, causing air bubbles to form that air strip VOCs as they rise through the water column. License information is available from Dr. Eric Klingel, IEG Technologies Corporation, 5015D West W.T. Harris Boulevard, Charlotte, NC 28269, (704) 599-4818.

e. EG&G Environmental. NoVOCs™ In-Well Stripping Groundwater Remediation Technology (# 5,180,503, # 5,389,267). This system, very similar to UVB, is an in-situ technology to remove VOCs from groundwater through a single well with two hydraulically separated screened intervals installed within a single permeable zone. Pressurized air is injected into the well below the static water table, aerating water within the well. The aerated water is less dense than water outside the well, creating a pressure gradient that draws water into the well through the lower screen. The VOCs volatilize into bubbles that encounter a packer where the VOCs in vapor form are released and removed with a vacuum blower for above-ground treatment. Air-lifted water within the well is usually discharged from the upper screen above the static water table to flush the capillary fringe. License information is available from Mr. Wayne J. DiBartola, EG&G Environmental, Foster Plaza 6, Suite 400, 881 Andersen Drive, Pittsburgh, PA 15220, (412) 920-5401.

f. Wasatch Environmental, Inc.; Density-Driven Convection (# 5,425,598). This system, also very similar to UVB, is an in-situ technology to remove VOCs from groundwater through a single well with two hydraulically separated screened intervals installed within a single permeable zone. Water inside the wellbore is aerated directly by injecting air at the base of the wellbore, which causes air bubbles to form, which air-strip VOCs as they rise through the water column and push aerated water upward through the wellbore and out the upper screened interval, simultaneously drawing water from the contaminated area around the lower screened interval.

License information is available from Mr. Leslie H. Pennington, Wasatch Environmental, Inc., 2240 West California Ave., Salt Lake City, UT 84104, (801) 972-8400.

g. Department of Energy; Chlorinated Hydrocarbon Bioremediation (# 5,384,048). This is an in-situ system for the bioremediation of chlorinated hydrocarbons in soil and groundwater by injection of a nutrient fluid and an oxygenated fluid with extraction so that both are drawn across the contaminated plume. The successful demonstration and patent utilize methane as the nutrient fluid and air as the oxygenated fluid. License information is available from Mr. Robert Marchick, Assistant General Counsel for Patents, U.S. Department of Energy, Washington, D.C. 20585, (202) 586-4792.

h. Department of Energy; Phosphate-Accelerated Bioremediation (# 5,480,549). This is a system for delivering vapor-phase nutrients, particularly triethyl or tributyl phosphate, to contaminated soil and groundwater to enhance in-situ bioremediation of contaminants. License information is available from Mr. Robert Marchick, Assistant General Counsel for Patents, U.S. Department of Energy, Washington, D.C. 20585, (202) 586-4792.

i. Integrated Environmental Solutions, Inc. Rapid Purging (# 5,509,760). This is a decontamination method that claims to put maximum remediation stress on a contaminated area of soil and groundwater, using positive pressure to push an uncontaminated gas throughout the contaminated area/volume and strip contaminants from it, and relying on a close spacing of air entry points.

j. Matrix Environmental Technologies; Oxygen Sparging (#5,874,001). This is a method and apparatus for in-situ removal of biodegradable contaminants from groundwater or soil or both by injecting oxygen gas into groundwater containing a biodegradable contaminant in a volume low enough to avoid migration or volatilization of the contaminant but high enough to enhance the rate of biodegradation of the contaminant.

8-4. Safety. The users of this EM shall refer to and comply with all applicable Federal regulations (OSHA) and USACE regulations including ER 385-1-92 in addressing all safety and health concerns, during all phases of IAS development, including pre-design investigations, design, construction, and operation and maintenance. Specifically, the designers shall comply with the requirements of ER 385-1-92 when developing the Health and Safety Design Analysis, which is subsequently used to draft Safety, Health and Emergency Response contract specifications for IAS construction based on UFGS 01351.

APPENDIX A
References

A-1. Required Publications.

a. Department of the Army.

ER 200-1-5

Policy for Implementation and Integrated Application of the U.S. Army Corps of Engineers Environmental Operating Principles and Doctrine

ER 385-1-92

Safety and Occupational Health Document Requirements for Hazardous, Toxic, and Radioactive Waste (HTRW) and Ordnance and Explosives.

ER 385-1-92, Appendix B

Safety and Health Elements for HTRW and OEW Documents.

ER 1110-1-263

Chemical Data Quality Management for Hazardous Waste Remedial Activities.

EP 415-1-261

Quality Assurance Representative Guide.

EP 1110-1-27

Operations and Maintenance of Extraction and Injection Wells.

EM 200-1-2

Technical Project Planning Guidance for HTRW Data Quality Design.

EM 200-1-6

Chemical Data Quality Assurance Guidance for HTRW Sites.

EM 200-1-18

Soil Vapor Extraction and Bioventing.

EM 1110-1-4000

Monitor Well Design, Installation, and Documentation of HTW Sites.

UFC 3-280-01A

Design Guidance for Ground Water/Fuel Extraction and Ground Water Injection Systems.

UFGS 01 35 30
Safety, Health, and Emergency Response (HTRW/UST).

b. Department of Energy (DoE).

EM-0135P
VOCs in Non-Arid Soils Integrated Demonstration: Technology Summary, February 1994.

c. Department of Navy.

NRL/PU/6115-99-384
Allmon, W.E, Everett, L.G., Lightner, A.T., Boyd, T.J., and Spargo, B.J. Groundwater Circulating Well Technology Assessment, Naval Research Laboratory. NRL/PU/6115-99-384.

Navy (2001)
Navy. Final Air Sparging Guidance Document. NFESC Technical Report TR-2193-ENV, 2001.

d. U.S. Environmental Protection Agency (USEPA).

USEPA (1975)
USEPA. Manual of Water Well Construction Practices. EPA/570/9-75/001. 1975. Updated 3/19/97.

USEPA (1985)
USEPA. An Introduction to Ground-Water Tracers. EPA/600/2-85/022. Robert S. Kerr Environmental Research Laboratory, Office of Research, and Development, ADA, OK 74280, 1985.

USEPA (1986)
USEPA. Test Methods for Evaluating Solid Waste, Physical/Chemical Methods. SW-846, 3rd ed., 1986, with promulgated updates July 1992 and September 1994.

USEPA (1991)
USEPA. Sampler's Guide to the Contract Laboratory Program. EPA/540/P-90/006, 1991.

USEPA (1992)
USEPA. A Technology Assessment of Soil Vapor Extraction and Air Sparging. EPA/600/R-92/173. Risk Reduction Engineering Laboratory, Office of Research and Development, Cincinnati, OH, 1992.

USEPA (1994)
USEPA. Manual: Alternative Methods for Fluid Delivery and Recovery. EPA/625/R-94/003, September, 1994.

USEPA (1995a)

USEPA. How to Evaluate Alternative Cleanup Technologies for Underground Storage Tank Sites: A Guide for Corrective Action Plan Reviewers. EPA/510/B-95/007. Office of Underground Storage Tanks. Washington, DC, 1995.

USEPA (1995b)

USEPA. Subsurface Volatilization and Ventilation System (SVVS): Innovative Technology Evaluation Report. EPA/540/R-94/529. National Risk Management Research Laboratory, Office of Research and Development, Cincinnati, OH, 1995.

USEPA (1996)

USEPA. Assessing UST Corrective Action Technologies: Diagnostic Evaluation of In-Situ SVE-Based System Performance. EPA 600/R-96/041, 1996.

USEPA (1997a)

USEPA. Analysis of Selected Enhancements for Soil Vapor Extraction. EPA/542/R-97/007, 1997.

USEPA (1997b)

USEPA. Ground Water Issue—How Heat Can Enhance In-Situ Soil and Aquifer Remediation: Important Chemical Properties and Guidance on Choosing the Appropriate Technique. EPA/540/S-97/502, 1997.

USEPA (1998)

USEPA. Steam Injection for Soil and Aquifer Remediation. EPA/540/S-97/505, 1998.

USEPA (1997)

USEPA. The Rapid Optical Screening Tool (ROST) Laser-Induced Fluorescence (LIF) System for Screening of Petroleum Hydrocarbons in Subsurface Soils. EPA/600/R-97/020. National Exposure Research Laboratory, Las Vegas, NV, 1997.

USEPA (2000)

USEPA. Guidance on the Data Quality Objectives Process. EPA/600/R-96/055, 2000.

e. American Society for Testing and Materials (ASTM).

D422

Standard Test Method for Particle-Size Analysis of Soils.

D2216

Standard Test Method for Laboratory Determination of Water (Moisture) Content of Soil and Rock.

D2325

Standard Test Method for Capillary Moisture Relationships for Coarse- and Medium-Textured Soils by Porous-Plate Apparatus.

D2488

Standard Practice for Description and Identification of Soils (Visual-Manual Procedure).

D2850

Standard Test Method for Unconsolidated, Undrained Compressive Strength of Cohesive Soils in Triaxial Compression.

D4043

Standard Guidance for Selection of Aquifer-Test Method in Determining of Hydraulic Properties by Well Techniques.

D4044

Standard Test Method (Field Procedure) for Instantaneous Change in Head (Slug Tests) for Determining Hydraulic Properties of Aquifers.

D4050

Standard Test Method (Field Procedure) for Withdrawal and Injection Well Tests for Determining Hydraulic Properties of Aquifer Systems.

D4104

Standard Test Method (Analytical Procedure) for Determining Transmissivity of Nonleaky Confined Aquifers by Overdamped Well Response to Instantaneous Change in Head (Slug Test).

D4105

Standard Test Method (Analytical Procedure) for Determining Transmissivity and Storage Coefficient of Nonleaky Confined Aquifers by the Modified Theis Nonequilibrium Method.

D4106

Standard Test Method (Analytical Procedure) for Determining Transmissivity and Storage Coefficient of Nonleaky Confined Aquifers by the Theis Nonequilibrium Method.

D4750

Standard Test Method for Determining Subsurface Liquid Levels in a Borehole or Monitoring Well (Observation Well).

D5220

Water Content of Soil and Rock In-Place by the Neutron Depth Probe Method.

D5269

Standard Test Method for Determining Transmissivity of Nonleaky Confined Aquifers by the Theis Recovery Method.

D5270

Standard Test Method for Determining Transmissivity and Storage Coefficient of Bounded, Nonleaky, Confined Aquifers.

D5299

Decommissioning of Ground Water Wells, Vadose Zone Monitoring Devices, Boreholes and Other Devices.

D5314

Standard Test Methods for Soil Gas Monitoring in Vadose Zone.

D6771

Standard Practice for Low Flow Purging and Sampling for Wells and Devices Used for Ground Water Quality Investigations, January 2002.

E1739

Standard Guide for Risk-Based Corrective Action Applied at Petroleum Release Sites.

F481

Installation of Thermoplastic Pipe and Corrugated Tubing in Septic Tank Leach Fields.

f. Other.

Acomb et al. (1995)

Acomb, L.J., McKay, D., Currier, P., Berglund, S.T., Sherhart, V.T., and Benediktsson, C.V. Neutron probe measurements of air saturation near an air sparging well. In: Hinchee, R.E., Miller, R.N., and Johnson, P.C. (eds.) *In Situ Aeration: Air Sparging, Bioventing, and Related Remediation Processes*. Battelle Press, Columbus, OH. pp. 47–61, 1995.

Amerson et al. (2001)

Amerson, I.L., Bruce, C.L., Johnson, P.C., and Johnson, R.L. A multi-tracer push-pull diagnostic test for in-situ air sparging systems. *Bioremediation Journal*, Vol. 5, No. 4, pp. 349–362, 2001.

Baker et al. (1996)

Baker, R.S., Pemmireddy, R., and McKay, D. Evaluation of air-entry pressure during in-situ air sparging: A potentially rapid method of feasibility assessment. *Proceedings of the 1st International Symposium on In Situ Air Sparging for Site Remediation*. October 24 and 25, 1996, Las Vegas, NV. INET, Potomac, MD.

Bass and Brown (1996)

Bass, D.H., Brown, R.A. Air sparging case study database update. Proceedings of the 1st International Symposium on In Situ Air Sparging for Site Remediation. October 24 and 25, 1996, Las Vegas, NV. INET, Potomac, MD.

Bass et al. (2000)

Bass, D.H., Hastings, N.A. and Brown, R.A. Performance of Air Sparging Systems: A Review of Case Studies. *Journal of Hazardous Materials*, Vol. 72, pp. 101–119, 2000.

Clarke et al. (1996)

Clarke, A.N., Wilson, D.J., and Norris, R.D. Using models for improving in-situ cleanup of groundwater. *Environmental Technology*. July/August, pp. 34–41, 1996.

Clayton et al. (1995)

Clayton, W.S., Brown, R.A., Bass, D.H. Air sparging and bioremediation: The case for in situ mixing. In: Hinchee, R.E., Miller, R.N., and Johnson, P.C. (eds.) *In Situ Aeration: Air Sparging, Bioventing, and Related Remediation Processes*. Battelle Press, Columbus, OH. pp. 75–85, 1995.

Holbrook et al. (1998)

Holbrook, T.B., Bass, D., Boersma, P., DiGiulio, D.C., Eisenbeis, J., Hutzler, N.J., Roberts, E. Vapor Extraction and Air Sparging Design and Application. *WASTECH Innovative Site Remediation Technology Series*, Vol. 7. W.C. Anderson (ed.), American Academy of Environmental Engineers, Annapolis, MD, 1998.

Johnson (1998)

Johnson, P.C. Assessment of the Contributions of Volatilization and Biodegradation to In Situ Air Sparging Performance. *Environmental Science and Technology*. Vol. 32, pp. 276–281, 1998.

Johnson et al. (1993)

Johnson, R.L., Johnson, P.C., McWhorter, D.B., Hinchee, R.E., and Goodman, I. An overview of in situ air sparging. *Ground Water Monitoring and Remediation*. Fall, pp. 127–135, 1993.

Johnson et al. (1995)

Johnson, P.C., Johnson, R.L., Neville, C., Hansen, E.E., Stearns, S.M., and Dortch, I.J. Do conventional monitoring practices indicate in situ air sparging performance? In: Hinchee, R.E., Miller, R.N., and Johnson, P.C. (eds.) *In Situ Aeration: Air Sparging, Bioventing, and Related Remediation Processes*. Battelle Press, Columbus, OH. pp. 1–20, 1995.

Johnson et al. (1997)

Johnson, P.C., Johnson, R.L., Neville, C., Hansen, E.E., Stearns, S.M., and Dortch, I.J. An assessment of conventional in situ sparging pilot tests. *Ground Water*, Vol. 35, no. 5, pp. 765–774, 1997.

Johnson et al. (2001)

Johnson, P.C., Johnson, R.L., Bruce, C.L., and Leeson, A. *Advances in In-Situ Air Sparging/Biosparging*. *Bioremediation Journal*, Vol. 5, No. 4, pp. 251–266, 2001.

Leeson et al. (2002)

Leeson, A., Johnson P.C., Johnson R.L., Vogel, C.M., Hinchee, R.E., Marley, M., Peargin, T.; Bruce, C.L., Amerson, I.L., Coonfare, Chr. T., Gillespie, R.P., and McWhorter, D.B. *Air Sparging Design Paradigm—Environmental Security Technology Certification Program (ESCTP)*, Technical documents, August 2002.

Lundegard (1994)

Lundegard, P.D. Actual versus apparent radius of influence - An air sparging pilot test in a sandy aquifer. *Proceedings of the 1994 Conference for Petroleum Hydrocarbons and Organic Chemicals in Ground Water: Prevention, Detection, and Restoration*, Nov. 1994, Houston, TX.

Lundegard and Andersen (1996)

Lundegard, P.D., and Andersen, G. Multiphase numerical simulation of air sparging performance. *Ground Water*, Vol. 34, No. 3, pp. 451–460, 1996.

Marley and Bruell (1995)

Marley, M.C., and Bruell, C.J. *In Situ Air Sparging: Evaluation of Petroleum Industry Sites and Considerations for Applicability, Design, and Operation*. American Petroleum Institute Publication No. 4609. Washington, DC, 1995.

Plastics Pipe Institute (2001)

Plastics Pipe Institute (PPI) TR-21(2001) *Thermal Expansion and Contraction in Plastic Piping Systems*.

Reddy et al. (1995)

Reddy, K.R., Kosgi, S., and Zhou, J. A review of in-situ air sparging for the remediation of VOC-contaminated saturated soils and groundwater. *Haz. Wastes and Haz. Materials*, Vol. 12, No. 2, pp. 97–118, 1995.

Wisconsin DNR (1993)

Wisconsin DNR. *Guidance for design, installation, and operation of in situ air sparging systems*. Publ-SW186-93. Wisconsin Department of Natural Resources, Madison, WI, 1993.

Wisconsin DNR (1995)

Wisconsin DNR. *Updated information and errata regarding guidance on design, installation and operation of in situ air sparging systems*. File Ref. 4440. Sept. 1, 1995. Wisconsin Department of Natural Resources, Madison, WI.

A-2. Related Publications.

ACRI (1996)

ACRI. POREFLOW—A software tool for multiphase fluid flow, heat, and mass transport in fractured porous media. User's Manual V.3.0X, Analytical and Computational Research, Inc., Los Angeles, CA, 1996.

Adams and Reddy (1999)

Adams, J.A., and Reddy, K.R. Laboratory Study of Air Sparging of TCE-Contaminated Saturated Soils and Groundwater. *Ground Water Monitoring and Remediation*, Vol. 19, No. 3, pp.182–190, 1999.

Adams and Reddy (2000)

Adams, J.A., and Reddy, K.R. Removal of Dissolved and NAPL-Phase Benzene Pools from Groundwater Using In-Situ Air Sparging. *Journal of Environmental Engineering, ASCE*, Vol. 126, No. 8, pp.697–707, 2000.

Ahlfeld et al. (1994)

Ahlfeld, D.P., Dahmani, A., and Ji, W. A conceptual model of field behavior of air sparging and its implications for application. *Groundwater Monitoring Review*, Fall, pp. 132–139, 1994.

APHA/AWWA/WEF (1992)

American Public Health Association, American Water Works Association, and Water Environment Federation. *Standard Methods for the Examination of Water and Wastewater*. Greenburg, A.E., Clesceri, L.S., and Eaton, A.D. (eds.) 18th edition, American Public Health Association Publications, Washington, DC, 1992.

Angell (1992)

Angell, K.G. In situ remedial methods: Air sparging. *The National Environmental Journal*. January/February, pp. 20–23, 1992.

Armstrong et al. (1994)

Armstrong, J.E., Frind, E.O., and McClellan, R.D. Nonequilibrium mass transfer between the vapor, aqueous, and solid phases in unsaturated soils during vapor extraction. *Water Resources Research*, Vol. 30, No. 2, pp. 355–368, 1994.

Bahr (1989)

Bahr, J.M. Analysis of nonequilibrium desorption of volatile organics during field test of aquifer decontamination. *J. Contam. Hydrol.*, Vol. 4, pp. 205–222, 1989.

Baker and Becker (1997)

Baker, R.S., and Becker, D.J. USACE's new air sparging Engineer Manual is an essential reference! *Pollution Engineering*(in press).

Baker et al. (1995)

Baker, R.S., Hayes, M.E., and Frisbie, S.H. Evidence of preferential vapor flow during in situ air sparging. In: Hinchee, R.E., Miller, R.N., and Johnson, P.C. (eds.) *In Situ Aeration: Air Sparging, Bioventing, and Related Remediation Processes*. Battelle Press, Columbus, OH. pp. 63–73, 1995.

Baker and McKay (1997)

Baker, R.S., and McKay, D.J. Evaluation of saturated zone airflow during in situ air sparging. Proceedings of the Fourth International symposium on In Situ and On-Site Bioremediation. April 28–May 1, 1997, New Orleans, LA. Battelle Press, Columbus, OH. (in press).

Bear (1992)

Bear, J. *Dynamics of Fluids in Porous Media*. American Elsevier, New York, NY, 1992.

Breckenridge et al. (1991)

Breckenridge, R.P., Williams, J.R., and Keck, J.F. Characterizing Soils for Hazardous Waste Site Assessments. Ground-Water Issue, EPA/540/4-91/003, Office of Research and Development, Office of Solid Waste and Emergency Response, 1991.

Boersma et al. (1993)

Boersma, P.M., Petersen, F.S., Newman, P., and Huddleston, R. Use of groundwater sparging to effect hydrocarbon biodegradation. Proc. 1993 Petroleum Hydrocarbons and Organic Chemicals in Ground Water: Prevention, Detection, and Restoration. Nov. 10-12, 1993, Houston, TX. API and NGWA, Washington, D.C., pp. 557–559, 1993.

Boersma et al. (1995)

Boersma, P.M., Piontek, K.R., and Newman, P.A.B. Sparging effectiveness for groundwater restoration. In: Hinchee, R.E., Miller, R.N., and Johnson, P.C. (eds.) *In Situ Aeration: Air Sparging, Bioventing, and Related Remediation Processes*. Battelle Press, Columbus, OH. pp. 39–46, 1995.

Brooks et al. (1999)

Brooks, M.C., Wise, W.R., and Annable, M.D. Fundamental changes in in-situ air sparging flow patterns. *Ground Water Monitoring and Remediation*, Vol. 19, No. 2, pp. 105–113, 1999.

Brown (1994)

Brown, R. Treatment of petroleum hydrocarbons in ground water by air sparging. In: Matthews, J.E. (ed.) *Handbook of Bioremediation*. CRC Press, Inc., Boca Raton, FL. pp. 61–85, 1994.

Brown and Fraxedas (1991)

Brown, R.A., and Fraxedas, R. Air sparging - Extending volatilization to contaminated aquifers. Proc: Symposium on Soil Venting. April 29-May 1, 1991, Houston, TX.

Brown et al. (1993)

Brown, A.B., Payne, R.E., and Perlwitz, P.F. Air sparge pilot testing at a site contaminated with gasoline. National Ground Water Association, Dublin, Ohio. Proceedings Petroleum Hydrocarbon

and Organic Chemicals in Ground Water. Prevention, Detection, and Restoration. pp. 429–444, 1993.

Clayton (1996)

Clayton, W.S. Air channeling in uniform soils: The exception rather than the rule. Proceedings of the 1st International Symposium on In Situ Air Sparging for Site Remediation. October 24 and 25, 1996, Las Vegas, NV. INET, Potomac, MD.

Downey and Hall 1994

Downey, D.C., and Hall, J.F. Addendum one to test plan and technical protocol for a field treatability test for bioventing—Using soil gas surveys to determine bioventing feasibility and natural attenuation potential. U.S. Air Force Center for Environmental Excellence. Brooks Air Force Base, TX, 1994.

Driscoll (1986)

Driscoll, F. Ground Water and Wells. 2nd edition, Johnson Division, UOP Inc. St. Paul, MN, 1986.

Dullien (1992)

Dullien, F.A.L. Porous Media: Fluid Transport and Pore Structure. 2nd edition, Academic Press, San Diego, CA, 1992.

Farr et al. (1990)

Farr, A.M., Houghtalen, R.J., and McWhorter, D.B. Volume estimation of light nonaqueous phase liquids in porous media. Ground Water, Vol. 28, No. 1, 48–56, 1990.

Gardner (1986)

Gardner, W.H. Water content. In: Klute, A. (ed.) Methods of Soil Analysis, Part I—Physical and Mineralogical Methods. Agronomy Monograph No. 9. (2nd edition). American Society of Agronomy-Soil Science Society of America, Madison, WI. pp. 493–544, 1986.

Gould and Sexton (1996)

Gould, T.F., and Sexton, S.E. Annual report: Building 1168 Treatability Study, Fort Wainwright, Alaska. Harding Lawson Associates. Anchorage, AL. Prepared for U.S. Army Corps of Engineers, Alaska District, 1996.

Gudemann and Hiller (1988)

Gudemann, H. and Hiller, D. In situ remediation of VOC contaminated soil and ground water by vapor extraction and ground water aeration. Proceedings of the Third Annual Haztech International Conference, Cleveland, OH, 1988.

Hazen et al. (1994)

Hazen, T.C., Lombard, K.H., Looney, B.B., Enzien, M.V., Dougherty, J.M., Fliermans, C.B., Wear, J., and Eddy-Dilek, C.A. Summary of In-Situ Bioremediation Demonstration (Methane Biostimulation) Via Horizontal Wells at the Savannah River Site Integrated Demonstration Project. Proceedings of the Thirty-third Hanford Symposium on Health and the Environment. In-Situ Remediation: Scientific Basis for Current and Future Technologies, Part 1, pp. 137–150. Battelle Press, Columbus, OH, 1994.

Herrling et al. (1991)

Herrling, B., Buermann, W., and Stamm, J. In-situ remediation of volatile contaminants in groundwater by a new system of “Vacuum-Vaporizer-Wells”. In: Weyer, K.U. (ed.) Subsurface Contamination by Immiscible Fluids. A.A. Balkema, Rotterdam, 1991.

Hewitt (1994)

Hewitt, A.D. Losses of trichloroethylene from soil during sample collection, storage, and laboratory handling. CRREL Special Report 94-8. U.S. Army Cold Regions Research and Engineering Laboratory. Hanover, NH.

Hinchee (1994)

Hinchee, R. E. Air sparging state of the art. In: Hinchee, R.E. (ed.) Air Sparging for Site Remediation. Lewis Publishers, Boca Raton, FL, pp. 1-13, 1994.

Hinchee et al. (1992)

Hinchee, R.E., Ong, S.K., Miller, R.N., Downey, D.C., and Frandt, R. Test plan and technical protocol for a field treatability test for bioventing. U.S. Air Force Center for Environmental Excellence. Brooks Air Force Base, TX, 1992.

Homsey (1987)

Homsey, G.M. Viscous fingering in porous media. Annual Review of Fluid Mechanics, Vol. 19, pp. 271–311, 1987.

Ji et al. (1993)

Ji, W., Dahmani, A., Ahlfeld, D.P., Lin, J.D., and Hill III, E. Laboratory study of air sparging: Air flow visualization. Ground Water Monitoring and Remediation, Vol. 13, No. 4, pp. 115–126, 1993.

Johnson (1994)

Johnson, R.L. Enhancing biodegradation with in situ air sparging: A conceptual model. In: Hinchee, R.E. (ed.) Air Sparging for Site Remediation. Lewis Publishers, Boca Raton, FL, pp. 14–22, 1994.

Johnson et al. (1996a)

Johnson, R.L., Dupont, R.R., and Graves, D.A. Assessing UST Corrective Action Technologies: Diagnostic Evaluation of In Situ SVE-Based System Performance. National Management Research

Laboratory, Office of Research and Development, USEPA, Cincinnati, OH. EPA/600/R-96/041 (NTIS PB96-163597), 1996.

Johnson et al. (1996b)

Johnson, R.L., Thomson, N.R., and Johnson, P.C. Groundwater circulation during in situ air sparging. Proceedings of the 1st International Symposium on In Situ Air Sparging for Site Remediation. October 24 and 25, 1996, Las Vegas, NV. INET, Potomac, MD, 1996.

Jones et al. (1980)

Jones, T.L., Gee, G.W., and Heller, P.R. Psychrometric measurement of soil water potential: Stability of calibration and test of pressure-plate samples. *Soil Science*, Vol. 150, pp. 531–541, 1980.

Klecka et al. (1996)

Klecka, G.M., Wilson, J.T., Lutz, E., Klier, N., West, R., Davis, J., Weaver, J., Kampbell, D., and Wilson, B. Intrinsic remediation of chlorinated solvents in groundwater. Conf. on Natural Attenuation of Chlorinated Solvents. Headquarters Ogden Air Logistics Center (AFMC). Hill Air Force Base, UT, 1996.

Klute (1986)

Klute, A. Water retention: Laboratory methods. In: Klute, A. (ed.) *Methods of Soil Analysis, part 1—Physical and Mineralogical Methods*. Agronomy Monograph No. 9. (2nd edition). American Society of Agronomy-Soil Science Society of America, Madison, WI, pp. 635–662, 1986.

Larson and Falta (1996)

Larson, A.G., and Falta, R.W. Numerical simulation of field air sparging operations. In: Reddi, L.N. (ed.) *Non-Aqueous Phase Liquids (NAPLs) In Subsurface Environment: Assessment and Remediation*. ASCE, New York, NY, pp. 551–562, 1996.

Larson (1996)

Larson, R.B. Design, Installation and operational methods of implementing horizontal wells for in situ groundwater and soil remediation. Proceedings of the 1st International Symposium on In Situ Air Sparging for Site Remediation. October 24 and 25, 1996, Las Vegas, NV. INET, Potomac, MD, 1996.

Leeson et al. (1995)

Leeson, A., Hinchee, R.E., Headington, G.L., and Vogel, C.M. Air channel distribution during air sparging: A field experiment. In: Hinchee, R.E., Miller, R.N., and Johnson, P.C. (eds.) *In Situ Aeration: Air Sparging, Bioventing, and Related Remediation Processes*. Battelle Press, Columbus, OH, pp 215–222, 1995.

Lenhard and Parker (1990)

Lenhard, R.J., and Parker, J.C. Estimation of free hydrocarbon volume from fluid levels in monitoring wells. *Ground Water*. Vol. 28, No. 1, pp. 57–67, 1990.

Lombard et al. (1994)

Lombard, K.H., Borthen, J.W., and Hazen, T.C. The design and management of system components for in situ methanotrophic bioremediation of chlorinated hydrocarbons at the Savannah River site. In: Hincee, R.E. (ed.), *Air Sparging for Site Remediation*. Lewis Publishers, Boca Raton, FL, pp. 81–96, 1994.

Lundegard (1995)

Lundegard, P.D. Air sparging: Much ado about mounding. In: Hincee, R.E., Miller, R.N., and Johnson, P.C. (eds.) *In Situ Aeration: Air Sparging, Bioventing, and Related Remediation Processes*. Battelle Press, Columbus, OH, pp. 21–30, 1995.

Lundegard and LaBrecque (1996)

Lundegard, P.D., and LaBrecque, D. Integrated geophysical and hydrologic monitoring of air sparging flow behavior. *Proceedings of the 1st International Symposium on In Situ Air Sparging for Site Remediation*. October 24 and 25, 1996, Las Vegas, NV. INET, Potomac, MD, 1996.

Marley (1992)

Marley, M.C. Removing gasoline from soil and groundwater through air sparging. *Remediation*. Spring, pp. 121–131, 1992.

Marley and Hall (1996)

Marley, M.C., and Hall, R.L. Control of arsenic in ground water using sparging technologies. *Proceedings of the 1st International Symposium on In Situ Air Sparging for Site Remediation*. October 24 and 25, 1996, Las Vegas, NV. INET, Potomac, MD, 1996.

Marley and Li (1994)

Marley, M.C., and Li, F. Air sparging: An effective groundwater and soils remediation technology. In: Hincee, R.E. (ed.) *Air Sparging for Site Remediation*. Lewis Publishers, Boca Raton, FL, pp. 23–27, 1994.

Marley et al. (1991)

Marley, M.C., Walsh, M.T., and Nangeroni, P.E. A case study on the application of air sparging with vapor extraction at a gasoline spill site. In: Calabrese, E.J. and Kostecki, P.T. (eds.) *Hydrocarbon Contaminated Soils, Volume I*. Lewis Publishers, Chelsea, MI, pp. 423–432, 1991.

Marley et al. (1992a)

Marley, M., Hazebrouck, D.J., and Walsh, M.T. The application of in situ air sparging as an innovative soils and ground water remediation technology. *Ground Water Monitoring Review*, Vol. 12, No. 2, 137–145, 1992.

Marley et al. (1992b)

Marley, M.C., Hazebrouck, D.J., and Walsh, M.T. Air sparging in conjunction with vapor extraction for source removal at VOC spill sites. In: Calabrese, E.J. and Kostecki, P.T. (eds.) *Hydrocarbon Contaminated Soils, Volume II*. Lewis Publishers, Chelsea, MI, pp. 579–589, 1992.

Marley et al. (1994)

Marley, M.C., Droste, E.X., and Cody, R.J. Mechanisms that govern the successful application of sparging technologies. The 87th Annual Meeting of the Air and Water Waste Management Association, 1994.

McCray and Falta (1996)

McCray, J.E., and Falta, R.W. Defining the air sparging radius of influence for groundwater remediation. *J. Contam. Hydrol.*, 24, pp. 25–52, 1996.

McCray and Falta (1997)

McCray, J.E., and Falta, R.W. Numerical simulation of air sparging for remediation of NAPL contamination. *Ground Water*, Vol. 35, No. 1, pp. 99–110, 1997.

McKay and Acomb (1996)

McKay, D.J., and Acomb, L.J. Neutron moisture probe measurements of fluid displacement during in situ air sparging. *Groundwater Monitoring and Remediation*, Fall, pp. 86–94, 1996.

McKay and Baker (1997)

McKay, D.J., and Baker, R.S. Rapid qualification of air sparging for site remediation. In: Zubeck, H. (ed.) *Proc. Fifth Int. Symp. on Cold Region Development*. Anchorage, AK, May 4–10, 1997. ASCE, New York, NY (in press).

Mohr (1995)

Mohr, D.H. Mass transfer concepts applied to in situ air sparging. Presented at: Third International Symposium on In situ and On-Site Bioreclamation. April 24–27, San Diego, CA. Chevron Research and Technology Corporation, Richmond, CA, 1995.

Morton et al. (1996)

Morton, L.D., Falta, R.W., Henderson, D.S. and Kern, C.A. A technique for the direct determination of the aerated zone resulting from field air sparging operations. In: Reddi, L.N. (ed.) *Non-Aqueous Phase Liquids (NAPLs) In Subsurface Environment: Assessment and Remediation*. ASCE, New York, NY, pp. 127–138, 1996.

Newell and Ross (1991)

Newell, C., and Ross, R.R. Estimating Potential for Occurrence of DNAPL at Superfund Sites. Quick Reference Guide Sheet. USEPA 9355.4-07FS. Washington, DC, 1991.

NIOSH (1985)

NIOSH. Occupational Safety and Health Guidance Manual for Hazardous Waste Site Activities. NIOSH Publication No. 85-115, Washington, DC, 1985.

NRC (1994)

NRC. Alternatives for Groundwater Cleanup. National Academy of Sciences, Washington, DC, 1994.

Norris (1994)

Norris, R.D. In-situ bioremediation of soils and ground water contaminated with petroleum hydrocarbons. In: Matthews, J.E. (ed.) *Handbook of Bioremediation*. CRC Press, Inc., Boca Raton, FL, pp. 17–37, 1994.

Norris and Wilson (1996)

Norris, R.D., and Wilson, D.J. Mass transport effects in sparging and biosparging. *Proceedings of the 1st International Symposium on In Situ Air Sparging for Site Remediation*. October 24 and 25, 1996, Las Vegas, NV. INET, Potomac, MD, 1996.

Page et al. (1982)

Page, A.L., Miller, R.H., and Keeney, D.R. (eds.) *Methods of Soil Analysis, Part 2, Chemical and Microbiological Properties*, 2nd Edition. Agronomy 9. ASA/SSSA, Madison, WI, 1982.

Pankow et al. (1993)

Pankow, J.F., Johnson, R.L., and Cherry, J.A. Air sparging in gate wells in cutoff walls and trenches for control of plumes of volatile organic compounds (VOCs). *Groundwater*, Vol. 31, No. 4, pp. 654–663, 1993.

Pannell and Levy (1993)

Pannell, L., and Levy, B.S. An innovative tool for in-situ measurement of dissolved oxygen. Fluid screening methods for Hazardous Wastes and Toxic Chemicals, *Proceedings of the 1993 US EPA/A& WMA International Symposium*. February 1993, Las Vegas, NV.

Payne et al. (1995)

Payne, F.C., Blaske, A.R., VanHouten, G.A. Contamination removal rates in pulsed and steady-flow aquifer sparging. In: Hinchee, R.E., Miller, R.N., and Johnson, P.C. (eds.) *In Situ Aeration: Air Sparging, Bioventing, and Related Remediation Processes*. Battelle Press, Columbus, OH. pp. 177–183, 1995.

Payne et al. (1996)

Payne, F.C., Rogers, D.T., and Buehlman, M.D. Chlorinated solvent reductions induced by an aquifer sparge fence. *Proceedings of the 1st International Symposium on In Situ Air Sparging for Site Remediation*. October 24 and 25, 1996, Las Vegas, NV. INET, Potomac, MD.

Peterson et al. (2001)

Peterson, J.W., Murray, K.S., Tulu, Y.I., Peuler, B.D., and Wilkens, D.A. Air-flow geometry in air sparging of fine-grained sands. *Hydrogeology Journal*, Vol. 9, pp. 168–176, 2001.

Puls and Barcelona (1996)

Puls, R.W. and Barcelona, M.J. Low-Flow (Minimal Drawdown) Ground-Water Sampling Procedures. EPA/540/S-95/504. USEPA Ground Water Issue. Office of Research and Development, Office of Solid Waste and Emergency Response, 1996.

Reddy and Adams (2001)

Reddy, K.R., and Adams, J.A. Effects of Soil Heterogeneity on Air Flow Patterns and Hydrocarbon Removal During In-Situ Air Sparging. *Journal of Geotechnical and Geoenvironmental Engineering*, ASCE, Vol. 127, No. 3, pp.234–247, 2001.

Roosevelt and Corapcioglu (1998)

Roosevelt, S.E., and Corapcioglu, M.Y. Air Bubble Migration in a Granular Porous Medium: Experimental Studies. *Water Resources Research*, Vol. 34, No. 5, pp. 1131–1142, 1998.

Runchal and Sagar (1989)

Runchal and Sagar. POREFLO-3. A mathematical model for fluid flow, heat, and mass transport in variably saturated geologic media. User's Manual V.1.0, WHC-EP/0041, Westinghouse-Hanford Co., Richland, WA, 1989.

Rutherford et al. (1996)

Rutherford, K.W., Bass, D., McPhee, W., and Johnson, P.C. Estimation of oxygen mass transfer coefficients during air sparging. *Proceedings of the 1st International Symposium on In Situ Air Sparging for Site Remediation*. October 24 and 25, 1996, Las Vegas, NV. INET, Potomac, MD.

Schima et al. (1996)

Schima, S., LaBrecque, D.J., and Lundegard, P.D. Monitoring air sparging using resistivity tomography. *Ground Water Monitoring and Remediation*. Spring, pp. 131–138, 1996.

Sellers and Schreiber (1992)

Sellers, K.L., and Schreiber, R.F. Air sparging model for predicting ground water cleanup rate. *Proceedings of Petroleum Hydrocarbons and Organic Chemicals in Ground Water: Prevention, Detection, and Restoration*. November 4-6, Houston, TX. NGWA, Dublin, OH. pp. 365–376, 1992.

Siegrist and Jenssen (1990)

Siegrist, R.L., and Jenssen, P.D. Evaluation of sampling method effects on volatile organic compound measurements in contaminated soils. *Environmental Science Technology*, Vol. 24, No. 9, pp. 1387–1392, 1990.

Siegwald et al. (1996)

Siegwald, S.F., Wallace, G.W., Wade, A., Lee, W.A., and McKinney, K.C. Evaluation of the effective zones of sparging for a horizontal and vertical air sparging well: a full-scale one-year pilot study. *Proceedings of the 1st International Symposium on In Situ Air Sparging for Site Remediation*. October 24 and 25, 1996, Las Vegas, NV. INET, Potomac, MD.

Taylor and Jaffe (1991)

Taylor, S.W., and Jaffe, P.R. Enhanced in-situ biodegradation and aquifer permeability reduction. *Journal of Environmental Engineering*, Vol. 117, No. 1, pp. 25–46.

Testa and Paczkowski (1989)

Testa, S.M., and Paczkowski, M.T. Volume determination and recoverability of free hydrocarbon. *Groundwater Monitoring and Remediation*. Winter, pp. 120–128, 1989.

Topp et al. (1994)

Topp, G.C., Zegelin, S.J., and White, I. Monitoring soil water content using TDR: An overview of progress. *Proceedings of the Symposium on Time Domain Reflectometry in Environmental, Infrastructure, and Mining Applications*, September 1994, sponsored by the United States Bureau of Mines and the Infrastructure Technology Institute at Northwestern University, Evanston, IL.

USDOE (1995)

US Department of Energy. *In-Situ Air Stripping Using Horizontal Wells, Innovative Technology Summary Report*, US Dept. of Energy, Office of Environmental Management, Office of Technology Development, April 1995.

Van Genuchten (1980)

van Genuchten, M.Th. A closed-form equation for predicting the hydraulic conductivity of unsaturated soils. *Soil Sci. Soc. Am. J.*, Vol. 44, pp. 892–898, 1980.

Vinsome and Shook (1993)

Vinsome, P.D.W., and Shook, G.M. Multi-purpose simulation. *Journal of Petroleum Science and Engineering*, Vol. 9, pp. 29–38.

Wade (1996)

Wade, A. Performance comparisons between a horizontal and a vertical air sparging well: A full-scale one-year pilot study. *Sixth Combined Innovative Technology Transfer and Chemists' Workshop*. USACE. April 8-12, 1996, Las Vegas, NV.

Ward et al. (1995)

Ward, C.H., Loehr, R.C., Nyer, E.K., Piotrowski, M.R., Thomas, J.M., Spain, J.C., Wilson, J.T., and Norris, R.D. *Bioremediation*. Anderson, W.C. (ed.) WASTECH. Volume 1. American Academy of Environmental Engineers, Annapolis, MD, 1995.

Wehrle (1990)

Wehrle, K. In-situ cleaning of CHC contaminated sites: Model-scale experiments using the air injection (in-situ stripping) method in granular soils. *Contaminated Soil*, Vol. 90, pp. 1061–1062, 1990.

White et al. (1972)

White, N.F., Sunda, D.K., Duke, H.R., and Corey, A.T. Boundary effects in desaturation of porous media. *Soil Science*, Vol. 113, No. 1, pp. 7–12.

Wilson et al. (1992)

Wilson, D.J., Kayano, S., Mutch, R.D., and Clarke, A.N. Groundwater cleanup by in-situ sparging. I. Mathematical modeling. Separation Science and Technology, Vol. 27, No. 8 and 9, pp. 1023–1041, 1992.

APPENDIX B

Henry's Law Constants (K_H , atm-m³/mol) For Selected Organic Compounds
 [Data Obtained from Mabey et al. (1982) and Mackay and Shiu (1981)]

Compound	K_H	T (K) ^a	Compound	K_H	T (K) ^a
Chlorinated Aromatics			1,2-Dichloropropane	2.3×10^{-3}	293
Chlorobenzene	3.6×10^{-3}	293/298	trans-1,3-Dichloropropene	1.3×10^{-3}	293/298
o-Dichlorobenzene	1.9×10^{-3}	293	Hexachlorocyclopentadiene	1.6×10^{-2}	298
m-Dichlorobenzene	3.6×10^{-3}	298	Hexachlorobutadiene	2.6×10^{-2}	293
p-Dichlorobenzene	3.1×10^{-3}	298	Monocyclic Aromatics (MAH)		
1,2,4-Trichlorobenzene	2.3×10^{-3}	298	Benzene	5.5×10^{-3}	298
Hexachlorobenzene	6.8×10^{-4}	293/298	Toluene	6.7×10^{-3}	293
Halogenated Nonaromatics			Ethylbenzene	6.6×10^{-3}	293
Methyl chloride	4×10^{-2}	293	o-Xylene	5×10^{-3}	298
Methyl bromide	2×10^{-1}	293	m-Xylene	7×10^{-3}	298
Methylene chloride	2×10^{-3}	293/298	p-Xylene	7.1×10^{-3}	298
Chloroform	2.9×10^{-3}	293	Styrene	2.75×10^{-3}	293
Bromodichloromethane	2.4×10^{-3}	293/295	1,2,3-Trimethylbenzene	3.2×10^{-3}	298
Dibromochloromethane	9.9×10^{-4}	293/295	1,2,4-Trimethylbenzene	5.9×10^{-3}	298
Bromoform	5.6×10^{-4}	293	1,3,5-Trimethylbenzene	6×10^{-3}	298
Dichlorodifluoromethane	3.0×10^1	298	Propylbenzene	7×10^{-3}	298
Trichlorofluoromethane	1.1×10^{-1}	293	Isopropylbenzene	1.3×10^{-3}	298
Carbon tetrachloride	2.3×10^{-2}	293	1-Ethyl-2-methylbenzene	4.3×10^{-3}	298
Chloroethane	1.5×10^{-1}	293	1-Ethyl-4-methylbenzene	5×10^{-3}	298
1,1-Dichloroethane	4.3×10^{-3}	293	n-Butylbenzene	1.3×10^{-2}	298
1,2-Dichloroethane	9.1×10^{-4}	293	Isobutylbenzene	3.3×10^{-2}	298
1,1,1-Trichloroethane	3×10^{-2}	298	sec-Butylbenzene	1.4×10^{-2}	298
1,1,2-Trichloroethane	7.4×10^{-4}	293	tert-Butylbenzene	1.2×10^{-2}	298
1,1,2,2-Tetrachloroethane	3.8×10^{-4}	293	1,2,4,5-Tetramethylbenzene	2.5×10^{-2}	298
Hexachloroethane	2.5×10^{-3}	293/295	n-Pentylbenzene	6×10^{-3}	298
Vinyl chloride	8.1×10^{-2}	298	Polycyclic Aromatics (PAH)		
1,1-Dichloroethene	1.9×10^{-2}	298/293	Naphthalene	4.6×10^{-4}	298
trans-1,2-Dichloroethene	6.7×10^{-2}	293	Acenaphthene	9.1×10^{-5}	298
cis-1,2-Dichloroethene	3.7×10^{-3}	293	Acenaphthylene	1.5×10^{-3}	293/298
Trichloroethene	9.1×10^{-3}	293	Anthracene	8.6×10^{-5}	298
Tetrachloroethene	1.5×10^{-2}	293	Phenanthrene	2.3×10^{-4}	298
Pesticides and Related Compounds, and PCBs, Dioxins and Furans			Ethers		
Ethylene dibromide (EDB) ^b	8.2×10^{-4}	298	Bis(chloromethyl)ether	2.1×10^{-4}	293/298
trans-Chlordane	9.4×10^{-5}	298	Bis(2-chloroethyl)ether	1.3×10^{-4}	293

Compound	K_H	T (K) ^a	Compound	K_H	T (K) ^a
Heptachlor	4×10^{-3}	298	2-Chloroethylvinylether	2.5×10^{-4}	293
Heptachlor epoxide	3.9×10^{-4}	298	Methyl tert-butylether (MTBE)	5.9×10^{-4}	293
Tetrahydrofuran	7×10^{-5}	298	Bis(2-chloroisopropyl)ether	1.1×10^{-4}	293
Aroclor 1016 ^c	3.3×10^{-4}	298	4-Chlorophenylphenylether	2.2×10^{-4}	293
Aroclor 1221 ^c	1.7×10^{-4}	298	4-Bromophenylphenylether	1×10^{-4}	293/298
Aroclor 1242 ^c	2×10^{-3}	298	Ketones		
Aroclor 1248 ^c	3.6×10^{-3}	298	Acetone	4×10^{-5}	293
Aroclor 1254 ^c	2.6×10^{-3}	—	2-Butanone	5.7×10^{-5}	293
Tetrahydrofuran	7×10^{-5}	298	4-Methyl-2-pentanone	1.4×10^{-4}	293

^aWhere two temperatures are given, the first is the temperature at which the vapor pressure was measured, and the second is the temperature at which the solubility was measured.

^bVapor pressure data from Stull (1947), and solubility data from Stephen and Stephen (1963).

^cMixture-average value.

APPENDIX C

Air Velocity Measurement and Flow Rate Calculation

C-1. Airflow rate measurements can be made using a variety of flowmeters, including rotameters, hot-wire anemometers, and flowmeters based on a differential pressure reading inside the pipe. Differential pressure related flowmeters include venturi meters, orifice plates, averaging pitot, and pitot tubes. Pitot tubes, rotameters, and hot-wire anemometers are typically the most appropriate and most commonly used measuring devices for IAS applications. Accurate measurements of airflow rates in IAS piping requires understanding the principles of operation of the flowmeter used. A reading of a velocity or flow rate on a flowmeter can represent different real volumetric flow rates, depending on parameters such as air temperature and pressure. A discussion of how to calculate the real volumetric flow rate in an IAS pipe follows.

C-2. [Figure C-1](#) shows a pitot tube installed in a small diameter pipe. To accurately measure the flow rate of air in this pipe, it is important to consider the physics of airflow in the pipe and the operation of the pitot tube. These considerations for the pitot tube can also be applied to the other flowmeters mentioned above.

a. The pitot tube consists of two pressure ports, one perpendicular to flow (static pressure port) and one pointed directly into the flow (stagnation or total pressure port). The differential pressure between these two ports is referred to as the velocity pressure and is a function of velocity.

b. Bernoulli's equation can be used to derive the relationship between velocity and velocity pressure:

$$p_t + h_t + v_t^2 / (2g) = p_s + h_s + v_s / (2g) \quad [\text{Bernoulli's equation.}] \quad (\text{C-1})$$

where the subscript t represents the property at the total pressure port and the subscript s represents the static pressure port. For IAS systems, $h_t = h_s$ and $v_s = 0$. Therefore:

$$\Delta p = p_s - p_t = v_t^2 / (2g) \quad (\text{C-2})$$

and

$$v = v_t = \sqrt{2g\Delta p} \quad (\text{C-3})$$

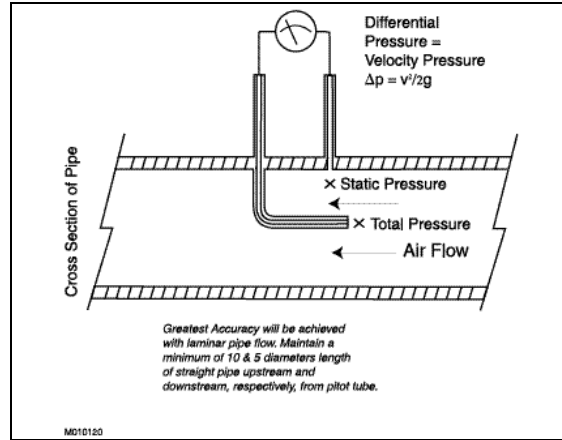

Figure C-1. Pitot tube flow measurement schematic.

In equation C-3, the differential pressure (or velocity pressure) is the height of fluid (air) and velocity is in length per unit time. However, differential pressure gauges do not have “height of air” scales, but usually have scales in units of mm water, cm water, or mm mercury (Hg) (or inches of water). Differential pressure may also be reported as pascals (ΔP ; force per unit area), which can be related to height of fluid: $\Delta P = \rho_{\text{air}} \times g \times \Delta p$. Rearranging and substituting into equation C-3 gives:

$$v_t = \sqrt{2\Delta P / \rho_{\text{air}}} \quad (\text{C-4})$$

Height of fluid is related to units for the measuring device (i.e., height of water or height of mercury) by: $\Delta p_{\text{air}} = \Delta p_{\text{md}} \times \rho_{\text{md}} / \rho_{\text{air}}$, where *md* refers to the units for the measuring device (e.g., mm of water). Therefore:

$$v_t = \sqrt{2g\Delta p_{\text{md}} \frac{\rho_{\text{md}}}{\rho_{\text{air}}}} \quad (\text{C-5})$$

Note again that velocity for the pitot tube is a function of the density of air. Only when $\rho_{\text{air}} = \rho_s = \rho_{\text{standard}}$, where the pressure and temperature at the static pressure port is at standard conditions (i.e., 20°C and 1 atm), can standardized charts be used without a correction for temperature and pressure.

c. Pitot tubes relate velocity to pressure at the point of the stagnation port, generally placed in the center of the pipe. IAS systems typically use pipe smaller than 150 mm, and measuring the velocity in the pipe at any point other than the center of the pipe is not practical. The velocity at the center of the pipe is the maximum velocity within the pipe and the velocity near the wall of the pipe approaches zero. Best engineering practice for compensating for the non-uniform velocity profile across the cross section of the pipe is to use an integrated average velocity, often assumed to be 0.9 times the velocity in the center of the pipe. The velocity is used

to calculate the volumetric flow rate, Q . Typically the measured flowrate, Q_{measured} , is obtained by assuming that the measurement point is at standard temperature and pressure conditions, i.e., $\rho_{\text{air}} = \rho_{\text{standard}} = 1.2 \text{ kg/m}^3$. For differential pressure expressed as force per area (e.g., pressure in Pascals or psi):

$$Q_{\text{measured}} = 0.9 \frac{\pi d^2}{4} \sqrt{2\Delta P / \rho_{\text{standard}}} \quad (\text{C-6})$$

or

$$Q_{\text{measured}} = 1.0 d^2 \sqrt{\Delta P / \rho_{\text{standard}}} \quad (\text{C-7})$$

For differential pressure expressed as height of water or height of mercury:

$$Q_{\text{measured}} = 0.9 \frac{\pi d^2}{4} \sqrt{2g\Delta p_{\text{md}} \frac{\rho_{\text{md}}}{\rho_{\text{standard}}}} \quad (\text{C-8})$$

or

$$Q_{\text{measured}} = 1.0 d^2 \sqrt{g\Delta p_{\text{md}} \frac{\rho_{\text{md}}}{\rho_{\text{standard}}}} \quad (\text{C-9})$$

d. Larger pipe can be fitted with a pitot tube that is constructed of concentric tubes that has the static pressure port located in the outer tube, while the stagnation pressure port is the tip of the inner tube.

e. Averaging pitot tubes work on the same principle of relating differential pressure within the pipe to airflow rate. Differential pressure is obtained with an averaging pitot tube by measuring pressure at ports in the upstream and downstream sides of a tube (typically 8 to 16 mm diameter) inserted into the pipe perpendicular to flow. There are a series of pressure ports along the tube that pneumatically “average” the differential pressure profile of the cross section of the pipe. The equations relating this average differential pressure to flow rate are specific to each averaging pitot tube manufacturer. Averaging pitot tubes are more accurate than conventional pitot tubes and can easily be moved from one measurement location to another. Thus, by simply installing measurement ports with compression seals at various locations in an SVE/BV system, flow measurements can be made for the system using a single averaging pitot tube and differential pressure gauge.

f. It is desirable to report flow rates normalized to a standard temperature and pressure so that flows can be readily compared. Airflow measuring equipment may be calibrated to air at different temperature and pressure than the air flowing through the IAS system. (If airflow

measuring equipment is calibrated, it is typically calibrated at standard conditions.) Calibrated gauges must be matched to the correct measuring devices and inside pipe diameter. In some instances, the gauges will have dual scales, with one scale indicating the velocity pressure, and the other indicating the air velocity or flow rate. Direct velocity or flow readings must be corrected to account for the differences between the temperature and pressure of the air being measured, and the temperature and air when the instrument was calibrated. The temperature and pressure (and therefore density) of air from an IAS compressor will be a large deviation from standard conditions. Only at the calibrated density would a flowmeter not require correction to obtain a standardized flow rate or velocity. With the exception of high-end electronic flow meters that can compute an internal correction for air at the measured temperature and pressure (i.e., density), air flowmeters do not provide a direct reading (i.e., without needing correction for air density) of standard flow or actual flow. (Standard flow refers to the equivalent flow rate if the air was flowing at standard conditions. Actual flow refers to the flow rate at the temperature and pressure that exists at the point of measurement.)

g. “Measured” flow rate may be directly read from a gauge that has a scale for direct reading of airflow rates, or may be stored electronically by a datalogger in a system with automated data acquisition. The corrected standardized flow rate (Q_{standard}) is equal to the product of the measured flow rate (Q_{measured}) and the square root of the ratio of the density at the calibrated (standard) conditions and the density of the air being measured.

$$Q_{\text{standard}} = Q_{\text{measured}} \sqrt{\frac{\rho_{\text{actual}}}{\rho_{\text{calibrated}}}} \quad (\text{C-10})$$

Applying the ideal gas law to the density ratio provides a more practical correction equation:

$$Q_{\text{standard}} = Q_{\text{measured}} \sqrt{\frac{273 + T_{\text{calibrated}}}{273 + T_{\text{actual}}} \cdot \frac{760 + P_g}{P_{\text{calibrated}}}} \quad (\text{C-11})$$

where

P_g = gauge pressure in mm Hg

T = temperature in °C

$P_{\text{calibrated}}$ = absolute pressure in mm Hg at the calibrated conditions.

Applying the assumption of calibration at standard conditions:

$$Q_{\text{standard}} = Q_{\text{measured}} \sqrt{\frac{293}{273 + T_{\text{actual}}} \cdot \frac{760 + P_g}{760}} \quad (\text{C-12})$$

or

$$Q_{\text{standard}} = K_{pt} Q_{\text{measured}} \quad (\text{C-13})$$

where K_{pt} is the Correction Factor shown in equation C-12. For convenience, [Figure C-2](#) presents a nomograph of K_{pt} that can be used to correct measured values to standard ones.

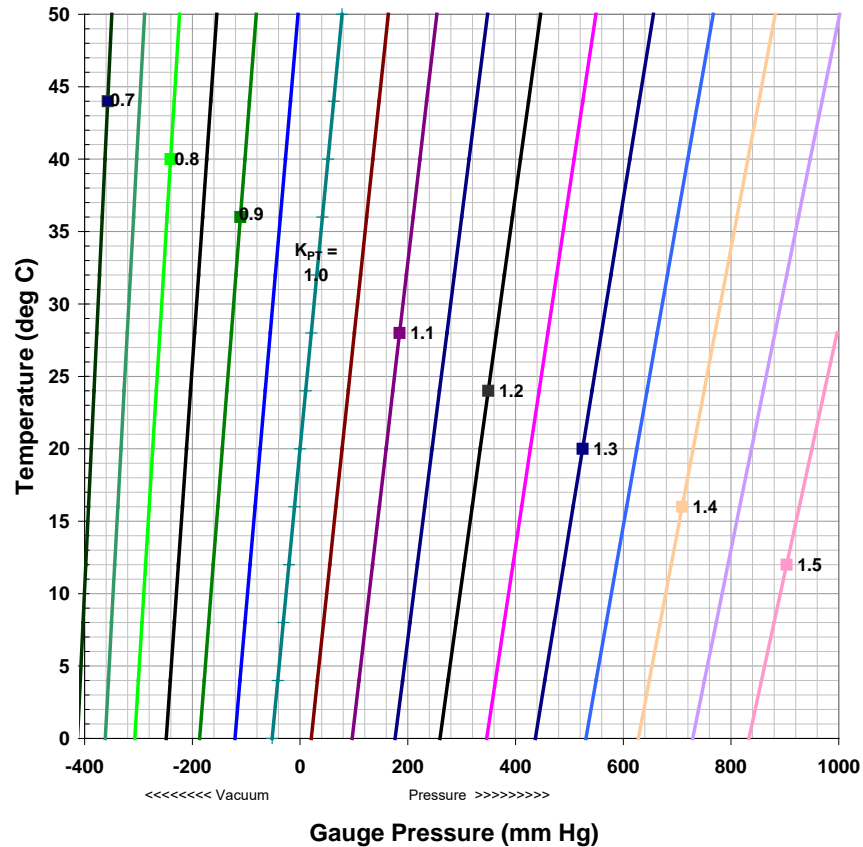

Figure C-2. Nomograph of flow correction factors (K_{PT}) for converting measured flow (at temperature and pressure different from STP) to standardized flow (i.e., flow rate at standard temperature and pressure).

h. The correction factor described by equations C-12 and C-13 is necessary for measurements made using rotameters and for volumetric airflow measurements based on a differential pressure measurement, such as pitot tubes, venturi meters, and orifice plates. In contrast, hot-wire anemometers measure the mass flux of air flowing past a hot wire and the anemometers' readouts typically yield velocities as if the flow was under standard temperature and pressure. (Note that if the actual temperature of the air being measured is close to the temperature of the hot wire, e.g., at the outlet of a thermal oxidizer, then this device may not provide an accurate flow measurement.)

i. An alternate method for calculating Q_{standard} is to calculate Q_{actual} (the actual air flow rate) using the actual temperature and pressure values at the measurement point, and then converting to a standard flow rate as shown below.

$$\rho_{\text{actual}} = \frac{(0.463 P_a)}{(273 + T_{\text{actual}})} \quad (\text{C-14})$$

In the above equation, density units are kg/m^3 , using units of degrees Celsius and mm Hg for temperature and absolute pressure (P_a), respectively. In the following equation, airflow rate is obtained in $\text{m}^3/\text{min.}$, using units of meters for inside diameter (d), mm Hg for velocity pressure (Δp_{md}), and kg/m^3 for air density (ρ_{actual}).

$$Q_{\text{actual}} = 0.9 \frac{\pi d^2}{4} 978.1 \sqrt{\Delta p_{\text{md}} / \rho_{\text{actual}}} \quad (\text{C-15})$$

Q_{actual} is then converted into a standard flow rate using the following equation. In the following equation, mm Hg and degrees C are used as units for gauge pressure (P_g) and temperature, respectively.

$$Q_{\text{standard}} = Q_{\text{actual}} \frac{293}{273 + T_{\text{actual}}} \cdot \frac{760 + P_g}{760} \quad (\text{C-16})$$